



KISS 4U V3

KISS 4U V3 CFL / KISS 4U V3 SKW / KISS 4U V3 PCI763

Doc. User Guide, Rev. 1.3

Doc. ID: 1064-5118

This page has been intentionally left blank

Disclaimer

Kontron would like to point out that the information contained in this user guide may be subject to alteration, particularly as a result of the constant upgrading of Kontron products. This document does not entail any guarantee on the part of Kontron with respect to technical processes described in the user guide or any product characteristics set out in the user guide. Kontron assumes no responsibility or liability for the use of the described product(s), conveys no license or title under any patent, copyright or mask work rights to these products and makes no representations or warranties that these products are free from patent, copyright or mask work right infringement unless otherwise specified. Applications that are described in this user guide are for illustration purposes only. Kontron makes no representation or warranty that such application will be suitable for the specified use without further testing or modification. Kontron expressly informs the user that this user guide only contains a general description of processes and instructions that may not be applicable in every individual case. In cases of doubt, contact Kontron.

This user guide is protected by copyright. All rights are reserved by Kontron. No part of this document may be reproduced, transmitted, transcribed, stored in a retrieval system, or translated into any language or computer language, in any form or by any means (electronic, mechanical, photocopying, recording, or otherwise), without the express written permission of Kontron. Kontron points out that the information contained in this user guide is constantly being updated in line with the technical alterations and improvements made by Kontron to the products and thus this user guide only reflects the technical status of the products by Kontron at the time of publishing.

Brand and product names are trademarks or registered trademarks of their respective owners.

©2019 by Kontron Europe GmbH

Kontron Europe GmbH

Gutenbergstraße 2
85737 Ismaning
Germany
www.kontron.com

Intended Use

This product, sold by Kontron, is also intended for the use in harsh industrial environments. The product can operate in a temperature range from 0°C to plus 50°C; the storage elements can withstand temperatures from minus 20°C to plus 70°C, and a humidity of 10 to 93 percent does not affect the function of the Product. This makes it particularly suitable for use in industrial automation, process control, high-end image processing and for SCADA/MES applications. This product can be installed in tower, desktop and rackmount environments, as more described in this user guide. You must comply with all product specifications stated in the product documentation and this user manual. If you intend, to incorporated the product into any total systems or applications, please carry out sufficient, compatibility and functions tests prior to any use or resale.

THIS PRODUCT IS NOT DESIGNED, MANUFACTURED OR INTENDED FOR USE OR RESALE FOR THE OPERATION OF APPLICATION IN A HAZARDOUS ENVIRONMENT, OR REQUIRING FAIL-SAFE PERFORMANCE, OR IN WHICH THE FAILURE OF PRODUCTS COULD LEAD DIRECTLY TO DEATH, PERSONAL INJURY, OR SEVERE PHYSICAL OR ENVIRONMENTAL DAMAGE (COLLECTIVELY "HIGH RISK APPLICATIONS").

You understand and agree that your use of Kontron products as a component in High Risk Applications is entirely at your own risk. To minimize the risks associated with your systems and applications, you must provide adequate design and operating safeguards. You are responsible to ensure that your systems (and any Kontron hardware or software products incorporated in your systems) meet all applicable requirements. Unless otherwise stated in the product documentation, the Kontron product is not provided with error-tolerance capabilities and therefore cannot be deemed as being engineered, manufactured or setup to be compliant for implementation or for resale as a component in High Risk Applications. All application and safety related information in this document (including application descriptions, suggested safety measures, suggested Kontron products, and other materials) is provided for reference only.

Revision History

Revision	Brief Description of Changes	Date of Issue	Author/Editor
1.0	Initial version	2019-Feb-07	CW
1.1	Removed noise data. Added no legacy UEFI only info. hint, 9 th Gen. processors to CFL variant, temperature sensors & redundant PSU. Updated EN/ IEC 60950-1 to EN/IEC 63368, mechanical details link, block diagrams, and PCI763 DIMMs to DDR4 2400 UDIMMs. Corrected PCI763 processor from 7 TH to 8 TH gen. to 6 TH to 7 TH gen.	2020-Apr-09	CW
1.2	Updated Figure 5, 6, 9, 26, 38, 43 and 44.	2021-Oct-11	CW
1.3	Removed Ubuntu, added new logo and updated diagrams with new logo	2023-Sept-15	CW

Terms and Conditions

Kontron warrants products in accordance with defined regional warranty periods. For more information about warranty compliance and conformity, and the warranty period in your region, visit <https://www.kontron.com/terms-and-conditions>.

Kontron sells products worldwide and declares regional General Terms & Conditions of Sale, and Purchase Order Terms & Conditions. Visit <https://www.kontron.com/terms-and-conditions>.

For contact information, refer to the corporate offices contact information on the last page of this user guide or visit our website [CONTACT US](#).

Customer Support

Find Kontron contacts by visiting: <https://www.kontron.com/support-and-services>.

Customer Service

As a trusted technology innovator and global solutions provider, Kontron extends its embedded market strengths into a services portfolio allowing companies to break the barriers of traditional product lifecycles. Proven product expertise coupled with collaborative and highly-experienced support enables Kontron to provide exceptional peace of mind to build and maintain successful products.

For more details on Kontron's service offerings such as: enhanced repair services, extended warranty, Kontron training academy, and more visit <https://www.kontron.com/support-and-services>.

Customer Comments

If you have any difficulties using this user guide, discover an error, or just want to provide some feedback, contact [Kontron Support](#). Detail any errors you find. We will correct the errors or problems as soon as possible and post the revised user guide on our website.

Symbols

The following symbols may be used in this user guide

⚠ DANGER

DANGER indicates a hazardous situation which, if not avoided, will result in death or serious injury.

⚠ WARNING

WARNING indicates a hazardous situation which, if not avoided, could result in death or serious injury.

NOTICE

NOTICE indicates a property damage message.

⚠ CAUTION

CAUTION indicates a hazardous situation which, if not avoided, may result in minor or moderate injury.



Electric Shock!

This symbol and title warn of hazards due to electrical shocks (> 60 V) when touching products or parts of products. Failure to observe the precautions indicated and/or prescribed by the law may endanger your life/health and/or result in damage to your material.



ESD Sensitive Device!

This symbol and title inform that the electronic boards and their components are sensitive to static electricity. Care must therefore be taken during all handling operations and inspections of this product in order to ensure product integrity at all times.



HOT Surface!

Do NOT touch! Allow to cool before servicing.



Laser!

This symbol inform of the risk of exposure to laser beam and light emitting devices (LEDs) from an electrical device. Eye protection per manufacturer notice shall review before servicing.



This symbol indicates general information about the product and the user guide.

This symbol also indicates detail information about the specific product configuration.



This symbol precedes helpful hints and tips for daily use.

For Your Safety

Your new Kontron product was developed and tested carefully to provide all features necessary to ensure its compliance with electrical safety requirements. It was also designed for a long fault-free life. However, the life expectancy of your product can be drastically reduced by improper treatment during unpacking and installation. Therefore, in the interest of your own safety and of the correct operation of your new Kontron product, you are requested to conform with the following guidelines.

High Voltage Safety Instructions

As a precaution and in case of danger, the power connector must be easily accessible. The power connector is the product's main disconnect device.

⚠ CAUTION

Warning

All operations on this product must be carried out by sufficiently skilled personnel only.

⚠ CAUTION



Electric Shock!

Before installing a non-hot-swappable Kontron product into a system always ensure that your mains power is switched off. This also applies to the installation of piggybacks. Serious electrical shock hazards can exist during all installation, repair, and maintenance operations on this product. Therefore, always unplug the power cable and any other cables which provide external voltages before performing any work on this product.

Earth ground connection to vehicle's chassis or a central grounding point shall remain connected. The earth ground cable shall be the last cable to be disconnected or the first cable to be connected when performing installation or removal procedures on this product.

Special Handling and Unpacking Instruction

NOTICE



ESD Sensitive Device!

Electronic products and their components are sensitive to static electricity. Therefore, care must be taken during all handling operations and inspections of this product, in order to ensure product integrity at all times.

⚠ CAUTION

Handling and operation of the product is permitted only for trained personnel within a work place that is access controlled. Follow the "General Safety Instructions for IT Equipment" supplied with the product.

Do not handle this product out of its protective enclosure while it is not used for operational purposes unless it is otherwise protected.

Whenever possible, unpack or pack this product only at EOS/ESD safe work stations. Where a safe work station is not guaranteed, it is important for the user to be electrically discharged before touching the product with his/her hands or tools. This is most easily done by touching a metal part of your system housing.

It is particularly important to observe standard anti-static precautions when changing piggybacks, ROM devices, jumper settings etc. If the product contains batteries for RTC or memory backup, ensure that the product is not placed on conductive surfaces, including anti-static plastics or sponges. They can cause short circuits and damage the batteries or conductive circuits on the product.

Lithium Battery Precautions

If your product is equipped with a lithium battery, take the following precautions when replacing the battery.

⚠ CAUTION

CAUTION: Risk of Explosion if the lithium battery is replaced by an incorrect type. Dispose of used lithium batteries according to the Instructions.

ATTENTION: Risque d'explosion si la pile au lithium est remplacée par une pile de type incorrect. Éliminez les piles au lithium usagées conformément aux instructions.

General Instructions on Usage

In order to maintain Kontron's product warranty, this product must not be altered or modified in any way. Changes or modifications to the product, that are not explicitly approved by Kontron and described in this user guide or received from Kontron Support as a special handling instruction, will void your warranty.

This product should only be installed in or connected to systems that fulfill all necessary technical and specific environmental requirements. This also applies to the operational temperature range of the specific product version that must not be exceeded.

In performing all necessary installation and application operations, only follow the instructions supplied with this user guide.

Keep all the original packaging material for future storage or warranty shipments. If it is necessary to store or ship the product then re-pack the product in the same manner as the product was delivered.

Special care is necessary when handling or unpacking the product. Refer to any special handling and unpacking instructions within this user guide.

Quality and Environmental Management

Kontron aims to deliver reliable high-end products designed and built for quality, and aims to complying with environmental laws, regulations, and other environmentally oriented requirements. For more information regarding Kontron's quality and environmental responsibilities, visit <http://www.kontron.com/about-kontron/corporate-responsibility/quality-management>.

Disposal and Recycling

Kontron's products are manufactured to satisfy environmental protection requirements where possible. Many of the components used are capable of being recycled. Final disposal of this product after its service life must be accomplished in accordance with applicable country, state, or local laws or regulations.

WEEE Compliance

The Waste Electrical and Electronic Equipment (WEEE) Directive aims to:

- ▶ Reduce waste arising from electrical and electronic equipment (EEE)
- ▶ Make producers of EEE responsible for the environmental impact of their products, especially when the product become waste
- ▶ Encourage separate collection and subsequent treatment, reuse, recovery, recycling and sound environmental disposal of EEE
- ▶ Improve the environmental performance of all those involved during the lifecycle of EEE



**Environmental protection is a high priority with Kontron.
Kontron follows the WEEE directive**

Table of Contents

Symbols	6
For Your Safety	7
High Voltage Safety Instructions	7
Special Handling and Unpacking Instruction	7
Lithium Battery Precautions.....	8
General Instructions on Usage	8
Quality and Environmental Management	8
Disposal and Recycling.....	8
WEEE Compliance.....	8
Table of Contents	9
List of Tables	11
List of Figures	11
1/ General Safety Instructions for IT Equipment	13
1.1. Operation of Laser Source Devices	14
1.2. Electrostatic Discharge (ESD).....	14
1.2.1. Grounding Methods	15
1.3. Instructions for the Lithium Battery	15
2/ Introduction	16
3/ Scope of Delivery	17
3.1. Accessories and Spare Parts.....	17
3.2. Shipment, Packaging and Unpacking.....	17
3.3. Type Label.....	17
4/ Product Description	18
4.1. Front Side.....	19
4.1.1. USB Ports	21
4.1.2. Controls and Indicators	21
4.1.3. Front Access Panel.....	22
4.1.4. Fan Assembly	23
4.1.5. Filter Pad and Filter Pad Holder	23
4.1.6. Drive Bays	24
4.2. Rear Side	25
4.2.1. Interfaces on the Rear Side	27
4.2.2. Additional Serial Ports.....	28
4.2.3. Power Supply Units.....	29
4.2.4. Potential Equalization Stud.....	30
4.3. Sides (Left and Right).....	31
4.4. Cover	32
4.5. System Configuration	33
4.5.1. System Configuration KISS 4U V3 CFL	33
4.5.2. System Configuration KISS 4U V3 SKW	34
4.5.3. System Configuration KISS 4U V3 PCI763	35
5/ System Extension	36
5.1. Mass Storage Options.....	36
5.2. Expansion Cards	36
6/ Thermal Considerations	38
6.1. Active Cooling.....	38
6.2. Temperature Sensor	38

6.3. Minimum System Clearance	38
6.4. Third Party Components	38
7/ Assembly.....	39
7.1. Opening and Closing the Cover	39
7.2. Accessing Internal Components	41
7.2.1. Installing and Removing Expansion Cards	41
8/ Installation	44
8.1. Installing the Rubber Feet	44
8.2. Removing the Handle Brackets	45
8.3. Removing the Front Access Panel and Front Access Panel Side-Plates	45
8.4. Installation as a Desktop	46
8.5. Installing in a 19" Industrial Rack	46
8.6. Installing Slide Rails (Option)	47
9/ Starting Up.....	50
9.1. Connecting the Power Connection	50
9.2. Operating System and Hardware Component Drivers	51
10/ Maintenance and Prevention.....	52
10.1. Cleaning the Filter Pad.....	52
10.2. Replacing the Fan Assembly.....	54
10.3. Replacing the Faulty Redundant PSU	55
10.4. Replacing the Lithium Battery.....	55
11/ Technical Data	57
11.1. Block Diagrams	57
11.2. Technical Specification	60
11.3. Power Specification	61
11.4. Mechanical Specification	62
11.5. Environmental Specification.....	62
11.6. Compliance	63
12/ Standard Interfaces- Pin Assignments.....	64
12.1. Keyboard Connector Pin Assignment	64
12.2. PS/2 Mouse Connector Pin Assignment	64
12.3. USB 2.0 Port Pin Assignment	64
12.4. Display Port Pin Assignment	65
12.5. COM 1 Connector Pin Assignment	65
12.6. DVI-D Connector Pin Assignment.....	65
12.7. DVI-I Connector Pin Assignment.....	66
12.8. LAN Connector Pin Assignment	66
12.9. USB 3.0 and USB 3.1 (Gen1/Gen2) Port Pin Assignment	66
12.10. USB 3.1 (Gen 2) Type C Port Pin Assignment.....	67
12.11. Audio Jack Pin Assignment	67
13/ Technical Support.....	68
13.1. Returning Defective Merchandise	68
14/ Storage and Transportation	70
14.1. Storage.....	70
14.2. Transportation	70
15/ Warranty.....	71
15.1. Limitation/Exemption from Warranty Obligation	71
Appendix A: List of Acronyms.....	72
About Kontron	73

List of Tables

Table 1: Scope of delivery	17
Table 2: Accessories and spares parts.....	17
Table 3: Power LED and HDD LED activity.....	22
Table 4: Drive bays.....	24
Table 5: Mass storage devices.....	36
Table 6: Expansion slots.....	36
Table 7: List of Acronyms.....	72

List of Figures

Figure 1: Laser radiation warning label	14
Figure 2: Type label example.....	17
Figure 3: Rackmount variant (closed front access panel).....	18
Figure 4: Desktop variant (closed front access panel).....	18
Figure 5: Rackmount variant (opened front access panel).....	18
Figure 6: Desktop variant (opened front access panel).....	18
Figure 7: Front side with front access panel closed	19
Figure 8: Handle bracket	19
Figure 9: Front side with front access panel open.....	20
Figure 10: Power button and USB 2.0 ports	21
Figure 11: LED indicators.....	22
Figure 12: Fan assembly.....	23
Figure 13: Rear side with mainboard.....	25
Figure 14: Rear side with PICMG 1.3(full-size) SBC.....	26
Figure 15: External mainboard interface panel KISS 4U V3 CFL.....	27
Figure 16: External mainboard interface panel KISS 4U V3 SKW.....	27
Figure 17: External mainboard interface panel KISS 4U V3 PCI763	28
Figure 18: 600 W PSU or optional 500 W Redundant PSU	29
Figure 19: Left side	31
Figure 20: Right side	31
Figure 21: Cover underside	32
Figure 22: Example of KISS 4U V3 CFL configuration with ATX mainboard (CFL).....	33
Figure 23: Example of KISS 4U V3 SKW configuration with ATX mainboard (SKW).....	34
Figure 24: Example of KISS 4U V3 PCI763 configuration with PICMG 1.3 (full-size) SBC.....	35
Figure 25: PCIe/PCI expansion slots type and location – PICMG 1.3 backplane SBC variant.....	37
Figure 26: Loosening knurled screw on the front side	39
Figure 27: Loosening knurled screw on the rear side.....	39
Figure 28: Pull and release the cover	39
Figure 29: Removing the cover	40
Figure 30: Card hold down bracket for short and long expansion cards and expansion card PCB holder	42
Figure 31: Steps to remove/install the card hold down brackets	42
Figure 32: Front access panel side-plate and handle bracket	45
Figure 33: Slide rail inner part to a KISS 4U V3 chassis.....	48
Figure 34: Slide rail in pulled-out position.....	48
Figure 35: Slide rail in pushed-in position.....	48
Figure 36: Assembling the slide rails in an industrial rack cabinet	49
Figure 37: Input power socket.....	50
Figure 38: Front side with filter pad holder.....	52
Figure 39: Fan assemble without filter pad holder.....	53
Figure 40: Filter pad holder (without filter pad).....	53
Figure 41: Filter pad holder (with filter pad)	53
Figure 42: Filter pad.....	53

Figure 43: Removing the fan assembly..... 54
Figure 44: Fan compartment (without fan assembly)..... 54
Figure 45: Block diagram KISS 4U V3 CFL.....57
Figure 46: Block diagram KISS 4U V3 SKW..... 58
Figure 47: Block diagram KISS 4U V3 PCI763..... 59

1/ General Safety Instructions for IT Equipment

Please read this passage carefully and take careful note of the instructions, which have been compiled for your safety and to ensure to apply in accordance with intended regulations. If the following general safety instructions are not observed, it could lead to injuries to the operator and/or damage of the product; in cases of non-observance of the instructions Kontron Europe is exempt from accident liability, this also applies during the warranty period.

The product has been built and tested according to the basic safety requirements for low voltage (LVD) applications and has left the manufacturer in safety-related, flawless condition. To maintain this condition and to also ensure safe operation, the operator must not only observe the correct operating conditions for the product but also the following general safety instructions:

- ▶ The product must be used as specified in the product documentation, in which the instructions for safety for the product and for the operator are described. These contain guidelines for setting up, installation and assembly, maintenance, transport or storage.
- ▶ The on-site electrical installation must meet the requirements of the country's specific local regulations.
- ▶ If a power cable comes with the product, only this cable should be used. Do not use an extension cable to connect the product.
- ▶ To guarantee that sufficient air circulation is available to cool the product, please ensure that the ventilation openings are not covered or blocked. If a filter mat is provided, this should be cleaned regularly. Do not place the product close to heat sources or damp places. Make sure the product is well ventilated.
- ▶ Only connect the product to an external power supply providing the voltage type (AC or DC) and the input power (max. current) specified on the Kontron Product Label and meeting the requirements of the Limited Power Source (LPS) and Power Source (PS2) of UL/IEC 62368-1.
- ▶ Only products or parts that meet the requirements for Power Source (PS1) of UL/IEC 62368-1 may be connected to the product's available interfaces (I/O).
- ▶ Before opening the product, make sure that the product is disconnected from the mains.
- ▶ Switching off the product by its power button does not disconnect it from the mains. Complete disconnection is only possible if the power cable is removed from the wall plug or from the product. Ensure that there is free and easy access to enable disconnection.
- ▶ The product may only be opened for the insertion or removal of add-on cards (depending on the configuration of the product). This may only be carried out by qualified operators.
- ▶ If extensions are being carried out, the following must be observed:
 - ▶ all effective legal regulations and all technical data are adhered to
 - ▶ the power consumption of any add-on card does not exceed the specified limitations
 - ▶ the current consumption of the product does not exceed the value stated on the product label
- ▶ Only original accessories that have been approved by Kontron Europe can be used.
- ▶ Please note: safe operation is no longer possible when any of the following applies:
 - ▶ the product has visible damages or
 - ▶ the product is no longer functioning
 In this case the product must be switched off and it must be ensured that the product can no longer be operated.
- ▶ Handling and operation of the product is permitted only for trained personnel within a work place that is access controlled.
- ▶ CAUTION: Risk of explosion if the lithium battery is replaced incorrectly (short-circuited, reverse-poled, wrong battery type). Dispose of used batteries according to the manufacturer's instructions.
- ▶ This product is not suitable for use in locations where children are likely to be present

Additional Safety Instructions for DC Power Supply Circuits

- ▶ To guarantee safe operation, please observe that:
 - ▶ the external DC power supply must meet the criteria for LPS and PS2 (UL/IEC 62368-1)

- ▶ no cables or parts without insulation in electrical circuits with dangerous voltage or power should be touched directly or indirectly
- ▶ a reliable functional earth connection is provided
- ▶ a suitable, easily accessible disconnecting device is used in the application (e.g. overcurrent protective device), if the product itself is not disconnectable
- ▶ a disconnect device, if provided in or as part of the product, shall disconnect both poles simultaneously
- ▶ interconnecting power circuits of different products cause no electrical hazards
- ▶ A sufficient dimensioning of the power cable wires must be selected – according to the maximum electrical specifications on the product label – as stipulated by EN62368-1 or VDE0100 or EN60204 or UL61010-1 regulations.

1.1. Operation of Laser Source Devices

Figure 1: Laser radiation warning label

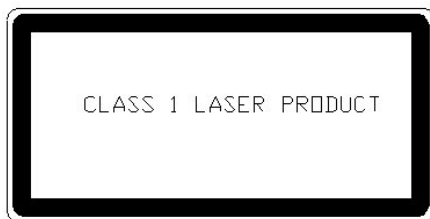

The optional DVD drive contains light-emitting diodes (LEDs) (classified in accordance with IEC 60825-1:2007: LASER CLASS 1) and therefore must not be opened. If the enclosure of such a drive is opened, invisible laser radiation is emitted. Do not allow yourself to be exposed to this radiation.

The laser system meets the Code of Federal Regulations (CFR), Title 21, 1040 - Performance standards for light-emitting products.



Laser!

Risk of exposure to laser beam and light emitting devices (LEDs) from DVD

- ▶ Do not open DVD drive due to invisible laser radiation
 - ▶ Check manufacture instructions eye protection maybe required
-

1.2. Electrostatic Discharge (ESD)



A sudden discharge of electrostatic electricity can destroy static-sensitive devices.

Proper packaging and grounding techniques are necessary precautions to prevent damage. Always take the following precautions:

1. Transport ESD-sensitive products in ESD-safe containers such as boxes or bags.
2. Keep electrostatic sensitive parts in their containers until they arrive at the ESD-safe workplace.
3. Always be properly grounded when touching sensitive products, components, or assembly.
4. Store ESD-sensitive products in protective packaging or on antistatic mats.

1.2.1. Grounding Methods

To avoid electrostatic damage, observe the following grounding guidelines:

1. Cover workstations with approved antistatic material. Always wear a wrist strap connected to the workplace. Always use properly grounded tools and equipment.
2. Use antistatic mats, heel straps, or air ionizers for more protection.
3. Always handle electrostatically sensitive components by their edge or by their casing.
4. Avoid contact with pins, leads, or circuitry.
5. Switch off power and input signals before inserting and removing connectors or connecting test equipment.
6. Keep work area free of non-conductive materials such as ordinary plastic assembly aids and Styrofoam.
7. Use only field service tools that are conductive, such as cutters, screwdrivers, and vacuum cleaners.
8. Always place drives and boards PCB-assembly-side down on the foam.

1.3. Instructions for the Lithium Battery

When replacing the mainboard's or Single Board Computer's (SBC) battery, observe the instructions described in Chapter 10.4: Replacing the Lithium Battery.

CAUTION

CAUTION: Risk of Explosion if the lithium battery is replaced by an incorrect type. Dispose of used lithium batteries according to the Instructions.

ATTENTION: Risque d'explosion si la pile au lithium est remplacée par une pile de type incorrect. Éliminez les piles au lithium usagées conformément aux instructions.



Do not dispose of lithium batteries in general trash collection. Dispose of the battery according to the local regulations dealing with the disposal of these special materials, (e.g. to the collecting points for dispose of batteries).

2/ Introduction

This user guide focuses on describing the special features of the KISS 4U V3 made by Kontron. New users are recommended to study the instructions within this user guide before switching on the power.

The KISS 4U V3 is a scalable 4U rackmount system equipped with either an ATX mainboard or backplane PICMG 1.3 full-size Single Board Computer (SBC), using 7th/8th /9th Gen Intel® Core™ i7/i5/i3 or Intel® Xeon® E family processors, supporting multiple expansion capabilities and external interfaces.

The KISS 4U V3 is designed for high performance, reliability and use in harsh Industrial environments offering total flexibility with installation options in a 19" industrial rack or on a desktop.

General KISS 4U V3 CFL features are:

- ▶ ATX mainboard
- ▶ 7th/8th /9th Gen Intel® Core™ i7/i5/i3 or Intel® Xeon E-21XX processor series
- ▶ Intel® C246 Express chipset
- ▶ Up to 64 GB memory with 4x DDR4-2666 UDIMM/ECC support with Xeon E
- ▶ Expansion slot:
 - ▶ 5x PCIe (full height, full length)
 - ▶ 2x PCI (full height, full length)
- ▶ Mass storage capabilities with M.2 HDD, SSD and DVD devices
- ▶ External Interfaces 4x USB 2.0, 4x USB 3.1, 2x DP 1.2, 1x DVI-D, 2x 1 Gb Ethernet, audio 1x serial port, and keyboard and mouse
- ▶ Active cooling

General KISS 4U V3 SKW features are:

- ▶ ATX Server mainboard
- ▶ Intel® Xeon W-21XX processor series
- ▶ Intel® C422 Workstation chipset
- ▶ Up to 512 GB memory with 8x DDR4-2666 RDIMM ECC
- ▶ Expansion slots:
 - ▶ 7x PCIe slots (full height, full length)
- ▶ Mass storage capabilities with M.2 HDD, SSD and DVD devices
- ▶ External Interfaces 8x USB 3.1, 2x 1Gb Ethernet, audio, 1x serial port, and keyboard and mouse
- ▶ Active cooling

General KISS 4U V3 PCI763 features are:

- ▶ PICMG 1.3 full-size CPU card
- ▶ 6th/7th Gen Intel® Core™ i7/i5/i3 processor
- ▶ Intel® Q170 chipset
- ▶ Up to 32 GB memory with DDR4-2400 UDIMM
- ▶ Expansion slots:
 - ▶ 4x PCI (full height, full length)
 - ▶ 3x PCI (full height, half length)
 - ▶ 2x PCIe 2.0 (full height, full length)
 - ▶ 3x PCIe 2.0 (full height, half length)
- ▶ Mass storage capabilities with HDD, SSD and DVD devices
- ▶ External Interfaces are 2x USB 3.0, 2x 1 Gb Ethernet and 1x DVI-I and 1x serial port
- ▶ Active cooling

3/ Scope of Delivery

Check that your delivery is complete, and contains the items listed in Table 1: Scope of delivery. If damaged or missing items are discovered, contact your dealer.

Table 1: Scope of delivery

Part	Qty.	Part Description
KISS 4U V3	1	System configuration as ordered
Access key	2	Key for the front access panel lock
Rubber feet	4	Self-adhesive feet for the bottom side when used as a desk top
AC power cable	1	With Europe rating, other cable ratings are optional
Safety instructions	1	Safety Instructions for IT equipment

3.1. Accessories and Spare Parts

Table 2: Accessories and spares parts

Accessories	Part Number	Part Description
	1016-5807	Slide rails
	1051-7200	Mounting kit slide rail
Spare parts	1035-6957	Filter pad
	1035-6968	Fan assembly

3.2. Shipment, Packaging and Unpacking

The KISS 4U V3 is packed together with all standard parts in a product specific cardboard packaging with suitable shock absorbers inside. Each item is packaged separately.

3.3. Type Label

Figure 2: Type label example



4/ Product Description

The KISS 4U V3 expands the Kontron KISS computer line. KISS 4U V3 is a scalable 4U rackmount system, equipped with either an ATX mainboard or backplane PICMG 1.3 (full-size) SBC. The flexible customer-specific hardware system configuration and the robust construction with excellent mechanical stability offers the superior qualities of a computer designed for operation in harsh industrial environment. The KISS 4U V3's design enables installation in 19" industrial racks or as a desktop.

Figure 3: Rackmount variant (closed front access panel)



Figure 4: Desktop variant (closed front access panel)



Figure 5: Rackmount variant (opened front access panel)



Figure 6: Desktop variant (opened front access panel)



The KISS 4U V3 is designed for horizontal operation. Vertical operation is possible.

Up to four drive bays are available, where drive bays D1, D2 and D3 are front accessible and drive bay D4 is either front accessible or an internal drive.

The power button and the LED indicators are located on the front side and consist of a power LED and a Hard Disk Drive (HDD) activity LED.

Two system fans attached by means of a slide-in fan assembly simplify the installation and removal of the two system fans, and enables replacement of the fans even during operation. A washable filter pad attaches to the fan assembly to protect against dust and dirt entering the KISS 4U V3. The filter pad can be replaced during operation.

The Power Supply Unit (PSU) is a single 600 W PSU or an optional 500 W redundant PSU for applications requiring a high level of availability.

Depending on the implemented mainboard (ATX mainboard or PICMG 1.3 SBC), different expansion cards can be installed to add additional functionality.

Ventilation holes on the front and rear sides the system fans on the front take in air and exhausts the air on the rear side. Objects must not obstruct ventilation holes

4.1. Front Side

The front side consists of two handle brackets for installation in a 19" Industrial rack and a front access panel with two front access panel side-plates attached via the handle brackets.

Figure 7: Front side with front access panel closed

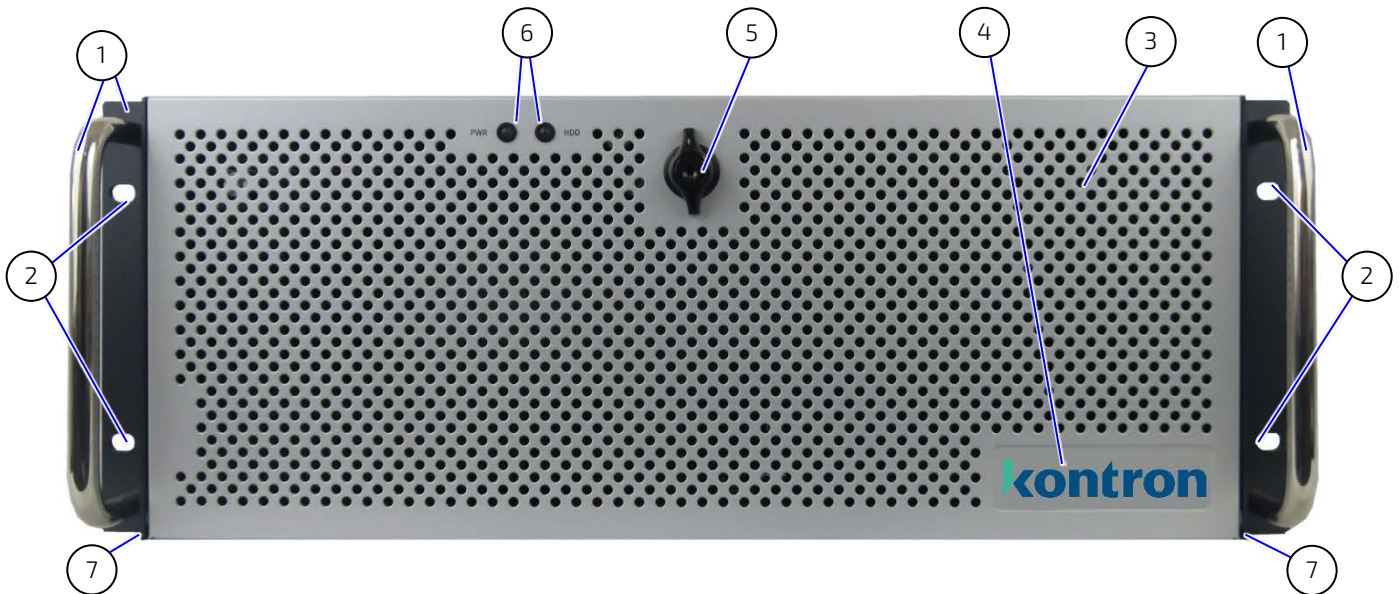

- | | |
|---|--|
| 1. Handle bracket | 4. Kontron Logo |
| 2. Mounting holes for 19" racks | 5. Key lock for the front access panel |
| 3. Front access panel with air intake ventilation holes | 6. LED indicators |
| | 7. Front access panel side-plate |

For use as a desktop system, remove both handle brackets (right side and left side), see Chapter 8.2: Removing the Handle Brackets and attach the rubber feet (included in delivery), see Chapter 8.1: Installing the Rubber Feet. Depending on the security requirements, the lockable front access panel and two front access panel side-plates can be removed or left in-place.

Figure 8: Handle bracket

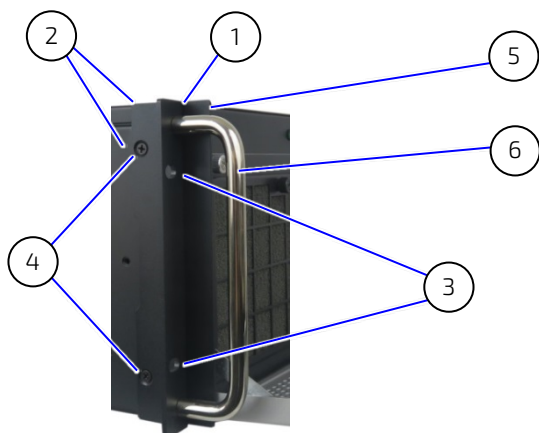

1. Handle bracket
2. Chassis and cover
3. Mounting holes for 19" racks
4. Screws to fasten handle bracket to chassis
5. Front access panel side-plate
6. Handle

The power button, LED indicators, two USB 2.0 ports, a filter pad holder and the integrated drives are located on the front side behind the front access panel.

Figure 9: Front side with front access panel open

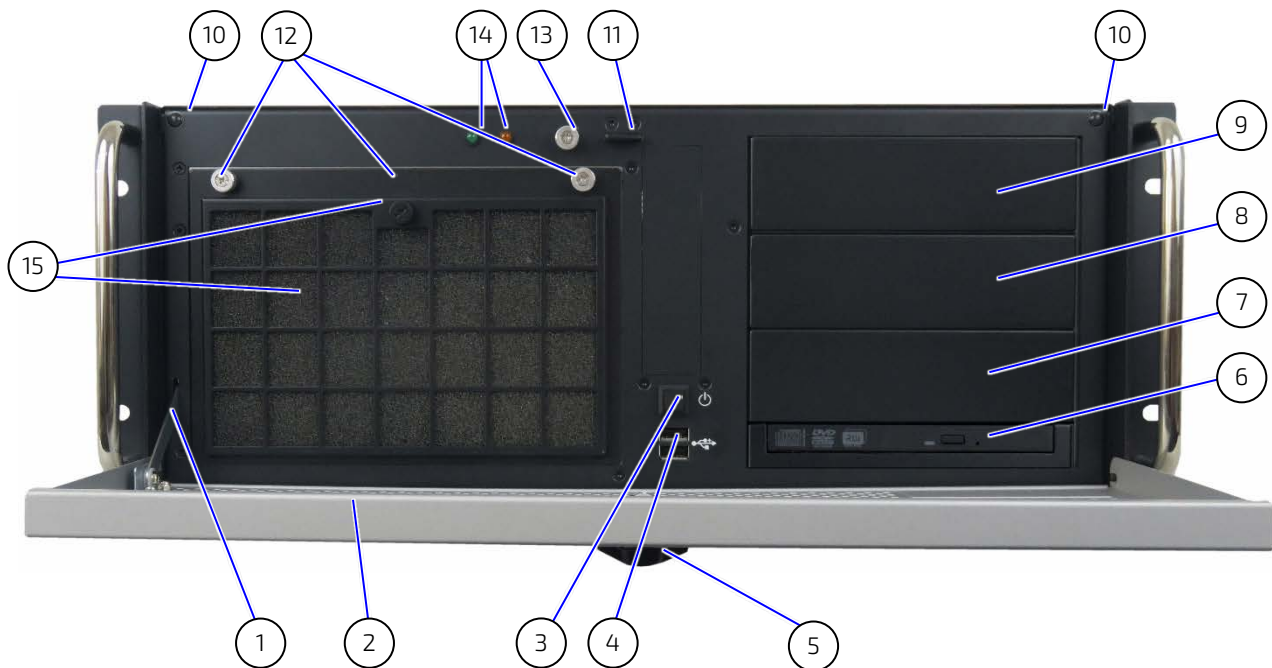

- | | |
|---|---|
| 1. Holder arm for the front access panel | 8. D2: 5.25" drive bay for SATA HDD, SSD, DVD 5.25" drives |
| 2. Front access panel with ventilation holes | 9. D1: 5.25" drive bay for SATA HDD, SSD, DVD 5.25" drives |
| 3. Power button | 10. Bump stop for the front access panel |
| 4. 2x USB 2.0 | 11. Slot for the locking mechanism |
| 5. Securing lock mechanism (two keys provided) | 12. Fan assembly with two knurled screws |
| 6. D4: 3.5" drive bay for internal 2.5"/3.5" SATA HDD or front accessible slim DVD drive | 13. Cover fastening screw on the front side |
| 7. D3: 5.25" drive bay for SATA HDD, SSD, DVD 5.25" drives | 14. LED indicators |
| | 15. Filter pad holder with filter pad and knurled screw |

4.1.1. USB Ports

The two USB 2.0 ports are located on the front side (Figure 9, pos. 4 and Figure 10, pos. 2), behind the front access panel.

Figure 10: Power button and USB 2.0 ports

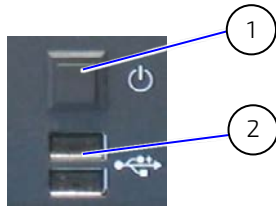

1. Power button
2. USB (2.0) ports



If USB devices are connected to the USB ports on the front side, the front access panel door cannot be closed and locked

4.1.2. Controls and Indicators

4.1.2.1. Power Button

The power button (Figure 9, pos. 3 and Figure 10 pos. 1) is located on the front side, behind the front access panel. Press the power button to switch on/off the product. Pressing the power button for longer than four seconds initiates a forced system shutdown before the power to the product is switched off.

⚠ WARNING

The power button does not disconnect from the mains power supply. When switched off using the power button, there is still a standby voltage of 5 VSB on the mainboard.

⚠ WARNING

AC Power cable and power connectors must always remain easily accessible. The KISS 4U V3 is only completely disconnected from the mains power supply when the power cable is disconnected, from the mains power socket or the KISS 4U V3's input power connector (Figure 13, pos. 3, Figure 14, pos.2).
If the end environment restricts access to the power cable, disconnection must be guaranteed using a separate cut-off fixture.

NOTICE

Performing a forced shutdown can lead to loss of data or other undesirable effects!

4.1.2.2. Power LED and HDD Activity LED

The LED indicators (Figure 9, pos. 14 and Figure 11) are located on the front side, behind the front access panel.

Figure 11: LED indicators

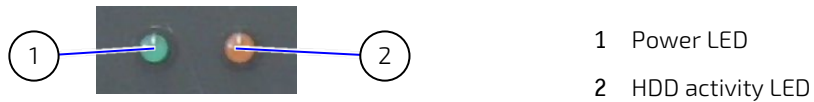

- 1 Power LED
- 2 HDD activity LED

Table 3: Power LED and HDD LED activity

LED	Description
Power LED (green)	LED lights up green when product starts up due to pressing the power button Prerequisite: Connection to an appropriate AC/DC power source.
HDD LED (orange)	LED lights up during hard disk activity

4.1.3. Front Access Panel

The securing lock mechanism (Figure 7, pos. 5) located on the front access panel protects against unauthorized use. When locked the front access panel cannot be opened without the key and the drives, filter pad holder and power button are not accessible.

The KISS 4U V3 can be operated without the front access panel, see Chapter 8.3: Removing the Front Access Panel and Front Access Panel Side-Plates.



Front access panel key must be kept safe and not be accessible to unauthorized persons.



If USB devices are connected to the USB ports on the front side, the front access panel door cannot be closed and locked

4.1.4. Fan Assembly

The two system fans (Figure 12, pos. 3) are integrated in a user-friendly, replaceable slide-in fan assembly (hot-swap) mounted in a fan compartment on the front side. The two system fans are temperature controlled via temperature sensors, to provide airflow for optimal active cooling. For information on how to replace the fan assembly, see Chapter 10.2: Replacing the Fan Assembly.

Figure 12: Fan assembly

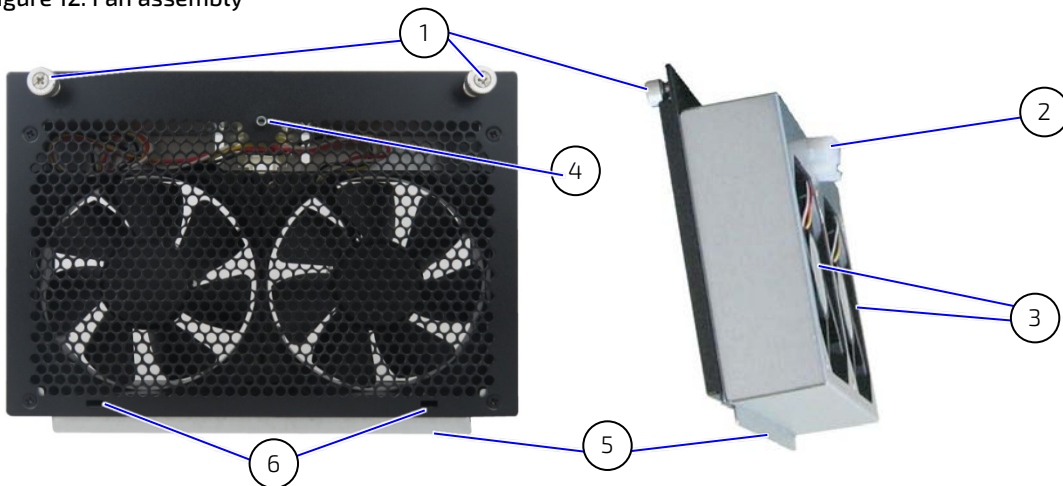

- | | |
|---|--|
| 1. Two knurled screws | 4. Bolt with tapped hole screw |
| 2. Connector for fan control | 5. Positioning bracket |
| 3. 2x fans (temperature controlled independently from each other) | 6. Positioning holes for the filter pad holder positioning latch |

⚠ CAUTION

Operation is permitted only with a functional fan assembly!
Replace a defective fan assemble only with an original fan assembly.

⚠ CAUTION

Fan assembly replaceable during operation
Replace fan only by qualified specialist or suitably instructed persons aware of the associated dangers. Keep hands and fingers away from rotating fan parts. Before removing the fan assembly, wait until the fans have totally stopped.



The filter pad holder can be fasten to the front side of the fan assembly either before or after the fan assembly is installed in the chassis.

4.1.5. Filter Pad and Filter Pad Holder

The filter pad and the filter pad holder (Figure 9, pos. 15) are located behind the front access panel (Figure 7, pos. 3). The filter pad protects the product from dust and dirt and will over time become soiled by pollution. If heavily soiled, the filter pad can cause excessive heating of the product. Kontron recommends cleaning the filter pad as often as necessary, see Chapter 10.1: Cleaning the Filter Pad.



The filter pad can be changed during operation.

The filter pad inserts into the filter pad holder and then fastens onto the fan assembly's front side using two positioning latches (Figure 12, pos. 6) and tapped hole bolt (Figure 12, pos. 4) on then fastening the filter pad holder's knurled screw (Figure 9, pos. 15).

4.1.6. Drive Bays

The KISS 4U V3 can be equipped with up to four drive bays Drive bays D1, D2 and D3 are front accessible (Figure 9, pos. 9, 8, 7) and drive bay D4 (Figure 9, pos.6) is either front accessible for slim drives or internally accessible for 3.5" SSD or HDD drives.

Table 4: Drive bays

Drive Bay	Location	Description
D1	Front accessible	One 5.25 " drive bay for SATA HDD, SSD, DVD drives
D2		One 5.25" drive bay for SATA HDD, SSD, DVD drives
D3		One 5.25" drive bay for SATA HDD, SSD, DVD drives
D4	Front accessible	One slim drive bay for slim DVD drives
	Internal	One 3.5" drive bay for 2.5" or 3.5" SATA SSD, HDD drives

The drives D1, D2, D3 and D4 can be used as separate drives or configured as a RAID array using the mainboard's chipset RAID.



Refer to the chipset specification for the RAID type and Intel® Rapid Storage Technology availability.

For additional storage, use the on-board M.2 slot with a M.2 memory module, see Chapter 5/System Extension.

4.2. Rear Side

The rear panel includes the external interfaces of the integrated mainboard (micro-ATX or PICMG 1.3 SBC), any additional interfaces of expansion cards and ports, power supply unit (PSU), and air exhaust openings.



The positioning and number of interfaces varies depending on the system configuration.

Figure 13: Rear side with mainboard

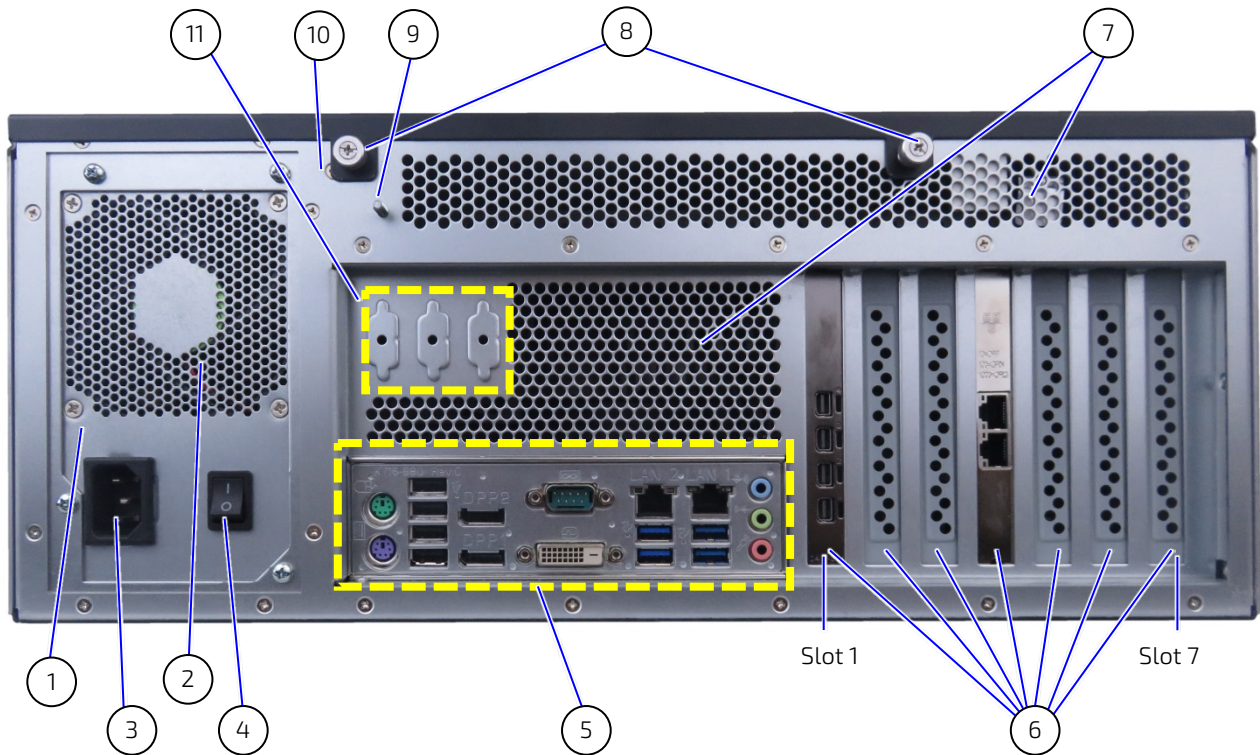

- | | |
|------------------------------------|---|
| 1. Power supply unit (PSU) | 8. Rear side of the cover with two knurled screws |
| 2. PSU ventilation holes | 9. Potential equalization stud |
| 3. Input power socket | 10. Externally accessible screw (countersunk screw M3x6) for the fastening of the retaining bracket |
| 4. PSU On/Off switch | 11. Cut-outs for optional interfaces routed to the rear (9-pin D-SUB type connector) |
| 5. Interfaces mainboard | |
| 6. Free expansion card slots | |
| 7. Ventilation holes (air exhaust) | |



The rear side of the KISS 4U V3 CFL and KISS 4U V3 SKW differ only in the interfaces of the mainboard (Figure 13, pos. 5).

Figure 14: Rear side with PICMG 1.3(full-size) SBC

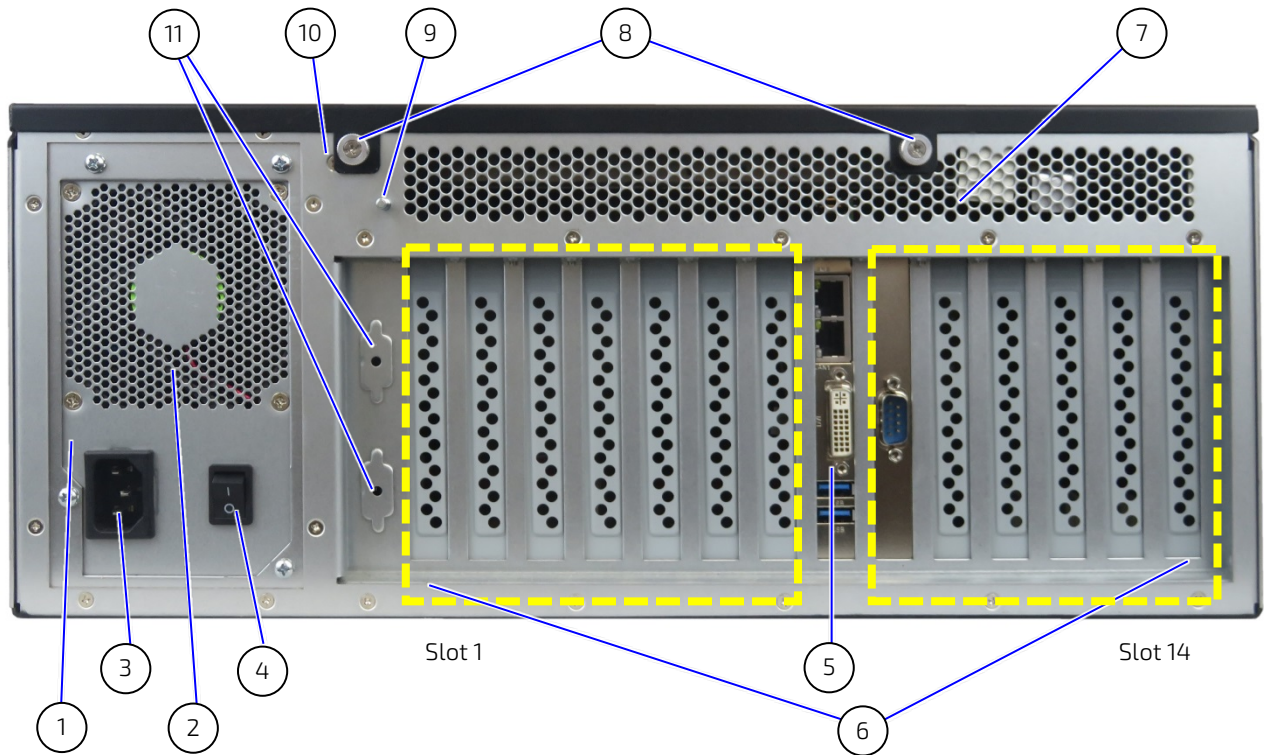

- | | |
|--|---|
| <ol style="list-style-type: none"> 1. Power supply unit (PSU) 2. PSU ventilation holes 3. Input power socket 4. PSU On/Off switch 5. Interface panel PICMG 1.3 SBC 6. Free expansion card slots 7. Ventilation holes (air exhaust) 8. Rear side of the cover with two knurled screws | <ol style="list-style-type: none"> 9. Potential equalization stud 10. cut-outs for optional (customer-specific) interfaces (9-pin D-SUB type connector) routed to the rear panel 11. Externally accessible screw (countersunk screw M3x6) for the fastening of the retaining bracket 12. Cut-outs for optional interfaces routed to the rear (9-pin D-SUB type) |
|--|---|

4.2.1. Interfaces on the Rear Side

Depending on the installed mainboard (micro-ATX or PICMG 1.3), the following external interfaces are available for peripherals.

4.2.1.1. External Interface Panel KISS 4U V3 CFL

Figure 15: External mainboard interface panel KISS 4U V3 CFL

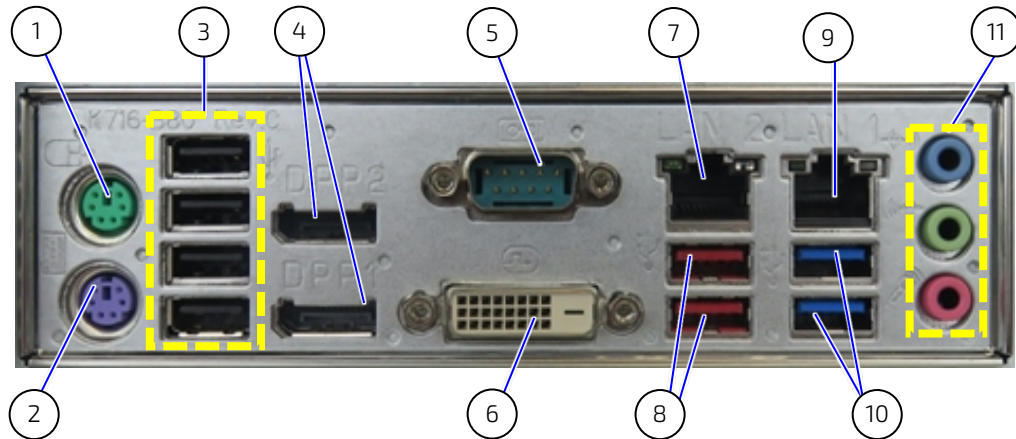

- | | |
|----------------------|-------------------------------|
| 1. Mouse | 7. LAN2 |
| 2. Keyboard | 8. 2x USB 3.1 (Gen 2) Type A |
| 3. 4x USB 2.0 | 9. LAN1 (iAMT) |
| 4. 2x DP V1.2 | 10. 2x USB 3.1 (Gen 1) Type A |
| 5. Serial port (COM) | 11. Audio |
| 6. DVI-D | |

Figure 16: External mainboard interface panel KISS 4U V3 SKW

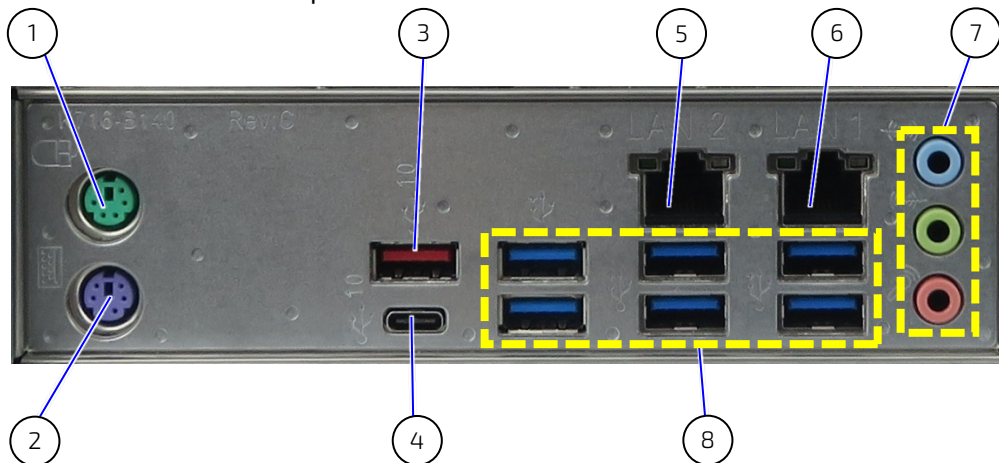

- | | |
|---------------------------|------------------------------|
| 1. Mouse | 5. LAN2 |
| 2. Keyboard | 6. LAN1 (iAMT) |
| 3. USB 3.1 (Gen 2) Type A | 7. Audio |
| 4. USB 3.1 (Gen 2) Type C | 8. 6x USB 3.1 (Gen 1) Type A |

4.2.1.2. External Interface Panel KISS 4U V3 PCI763

Figure 17: External mainboard interface panel KISS 4U V3 PCI763

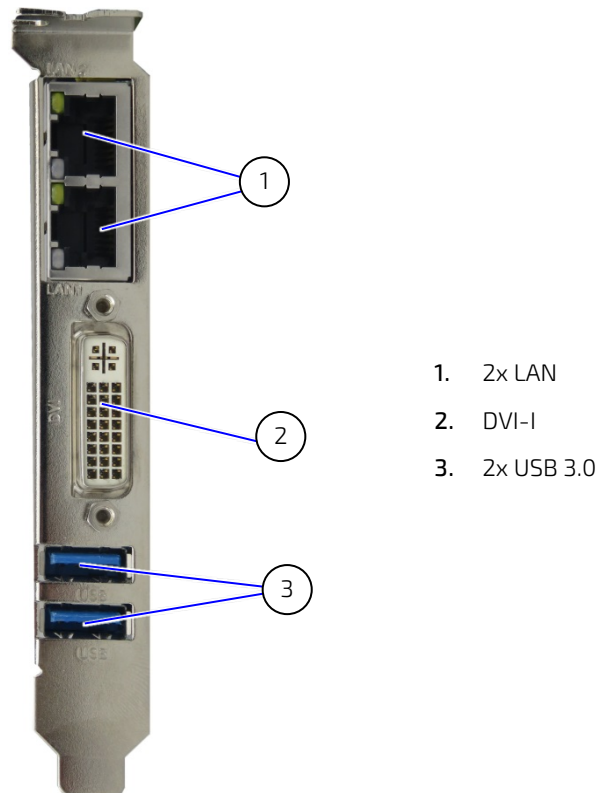

4.2.2. Additional Serial Ports

Depending on the installed mainboard (micro-ATX or PICMG 1.3 SBC), on-board interfaces such as serial ports can be routed to the rear panel (refer to Figure 13, pos. 11 and Figure 14, pos. 11).



For information and technical data, refer to the installed mainboard's user guide.

4.2.3. Power Supply Units

The Power Supply Unit (PSU) is located on the rear side and supplies the required internal voltages using standard certified cabling. The default PSU is a single PSU with the option for a redundant PSU for high availability applications.

Single PSU (default)

The single 600 W PSU supports a nominal input voltage of 100 V to 240 V.

Redundant PSU (option)

The redundant 500 W PSU supports a nominal input voltage of 100 V to 240 V.

The redundant PSU contains two separate PSUs each capable of powering the KISS 4U V3-CFL alone and each supplied using a dedicated power cable connection to the mains power supply. To ensure the power cables are not accidentally removed from the input power sockets, the power connector is held firmly in place by cable holders.

If a PSU fails, the faulty PSU shuts down and generates a buzzing tone. Additionally, the indication LED changes color from green (active) to red (faulty), to indicate which PSU is faulty. The functional PSU takes over the full operation, until the faulty PSU is replaced, see Chapter 10.3: Replacing the Faulty Redundant PSU.

⚠ WARNING

Even when switched off using the power button parts of the product may still be energized! The product is only completely switched off by switching off using the power button and disconnecting the power cable from the mains power supply or PSUs Input power socket.

⚠ WARNING

AC Power cable and power connectors must always remain easily accessible. If the end environment restricts access to the power cable, disconnection must be guaranteed using a separate cut-off fixture.

NOTICE

Do not disconnect the power from the product while the product is switched on! Performing a forced shut down may lead to loss of data or other undesirable effects! Switch off using the power button to perform an orderly shutdown without data loss.

Figure 18: 600 W PSU or optional 500 W Redundant PSU

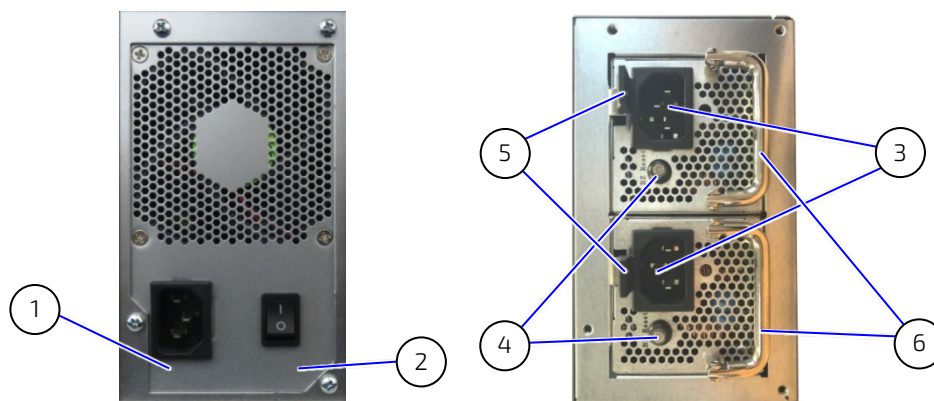

- | | |
|------------------------------------|---|
| 1. Input power socket (Single PSU) | 3. Redundant input power sockets |
| 2. PSU On/Off (single PSU) | 4. Buzzer reset switch with indicator LED Power |
| | 5. Power cable holder |
| | 6. Removal and insertion handle |

4.2.4. Potential Equalization Stud

The potential equalization stud is located on the rear side (see Figure 13 and Figure 14, pos. 9). The potential equalization stud is not a ground connection. The potential equalization stud can be connected to ensure that all systems have the same potential, even if positioned in a different location.



The potential equalization stud is not a ground connection. The potential equalization stud ensures that all connected systems share a common potential.

4.3. Sides (Left and Right)

On the left and right sides of the KISS 4U V3 are, six M4 tapped screw holes (Figure 19 and Figure 20, pos. 2).used for installation in a 19" industrial rack with slide rails.

Figure 19: Left side

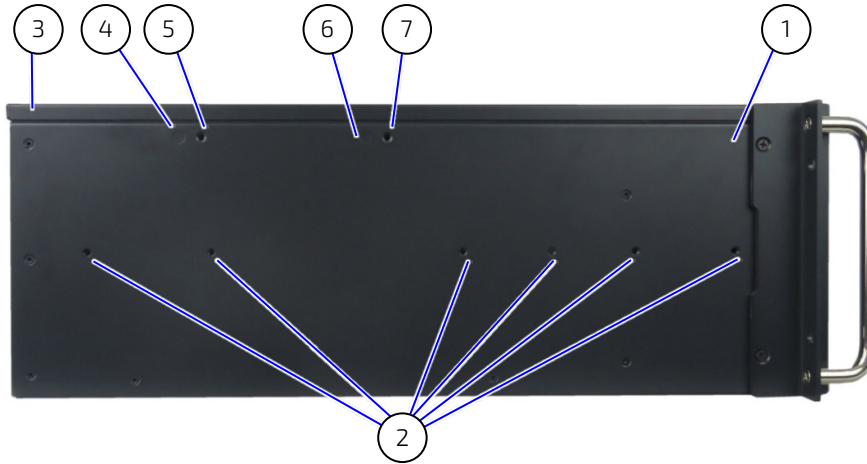

- | | |
|--|--|
| <ol style="list-style-type: none"> 1. Left side view of a KISS 4U V3 chassis 2. 6x M4 tapped holes (on both sides) 3. Cover 4. Internal bolt for card hold down bracket for long expansion cards (full-length) | <ol style="list-style-type: none"> 5. Externally accessible screw (countersunk screw M3x6) for card hold down bracket for long expansion cards (full-length) 6. Internal bolt for card hold down bracket for short expansion cards (half-length) 7. Externally accessible screw (countersunk screw M3x6) for card hold down bracket for short expansion cards (half-length) |
|--|--|

Figure 20: Right side

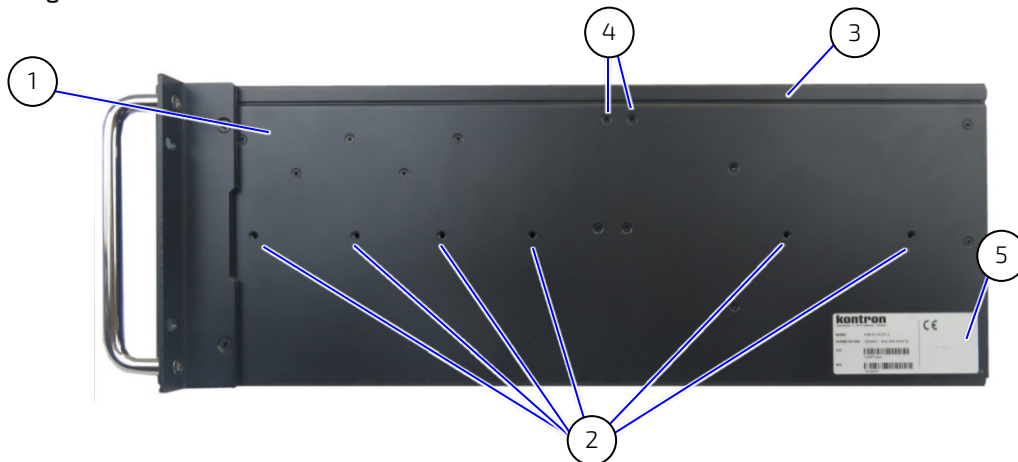

- | | |
|---|---|
| <ol style="list-style-type: none"> 1. Right side view of a KISS 4U V3 chassis 2. 6x M4 tapped holes (on both sides) 3. Cover | <ol style="list-style-type: none"> 4. Screws for internal card hold down bracket for long expansion cards (full-length) 5. Kontron Logo |
|---|---|

4.4. Cover

⚠ WARNING

Energy hazards-240 VA present inside the chassis!

Before removing the KISS 4U V3's cover, ensure that: the product is switched off and disconnected from the mains power supply.

⚠ WARNING

Recommended intended used is closed and locked

Only when the cover is secured is it ensured that the operator does not have access to the internal parts, loaded with hazardous energy. To close properly secure the cover knurled screws: one front side screw and two rear side screws.

The cover fixes to the chassis using two fixing brackets on the front side of the cover (Figure 21, pos. 3 and pos. 4), and fastens using two knurled screw on the rear side (Figure 21, pos. 6) and one knurled screw (Figure 9, pos. 13) on the front side of the cover. For information on how to open the cover, see Chapter 7.1: Opening and Closing the Cover.

Figure 21: Cover underside

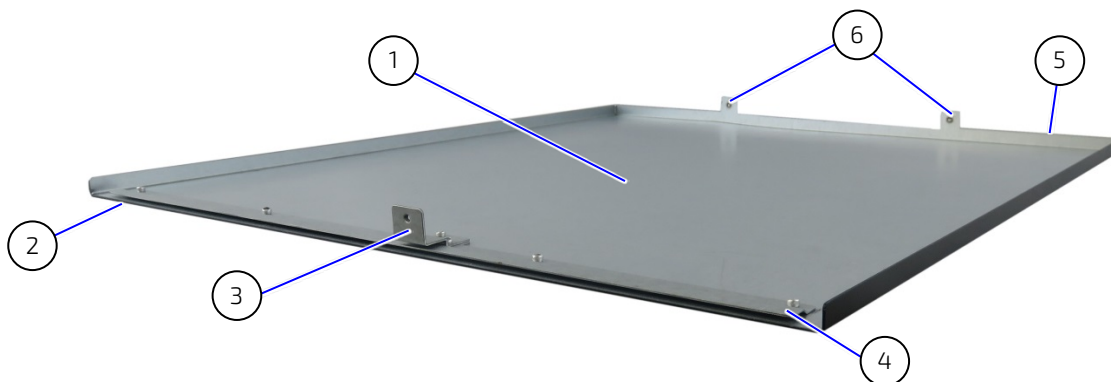

- | | |
|--|---------------------------------------|
| 1. Underside of cover | 4. Fixing bracket (on the front side) |
| 2. Cover front side | 5. Cover rear side |
| 3. Angulated centering fixing bracket with tapped hole (on the front side) | 6. Two knurled screws |

4.5. System Configuration

4.5.1. System Configuration KISS 4U V3 CFL

Figure 22: Example of KISS 4U V3 CFL configuration with ATX mainboard (CFL)

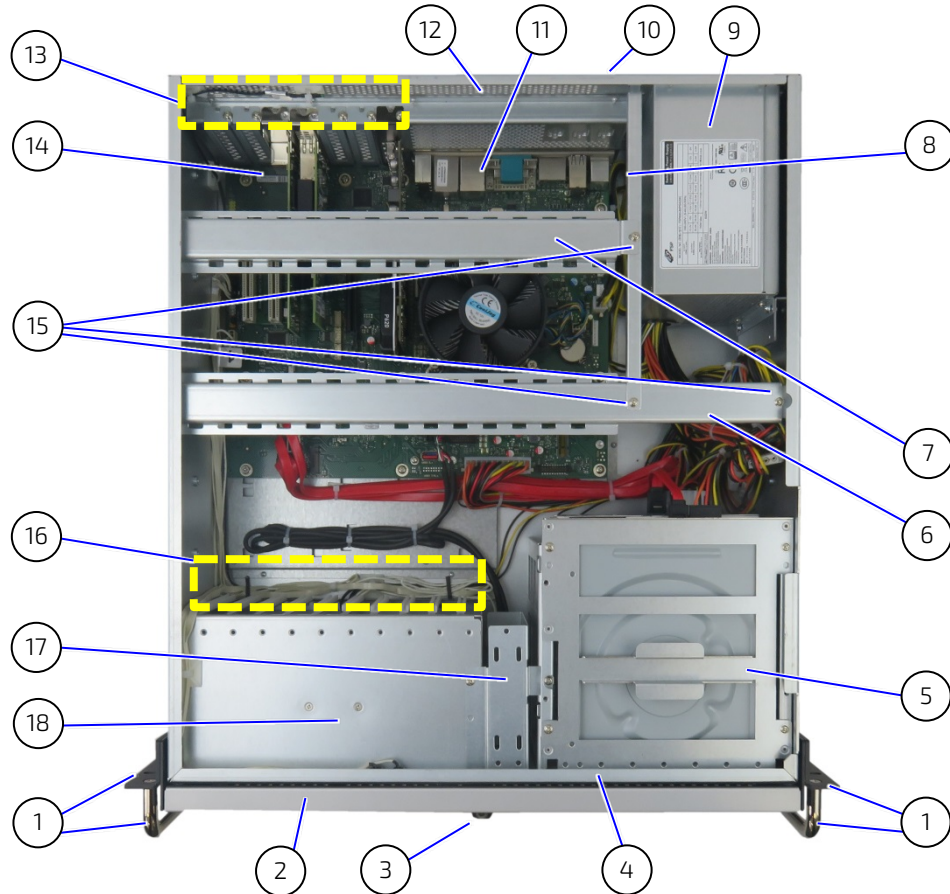

- | | |
|---|--|
| 1. 19" rack mountable bracket with handle | 9. Power supply unit (PSU) |
| 2. Front access panel | 10. Potential equalization stud |
| 3. Access panel lock | 11. External interfaces of the mainboard |
| 4. Cover retaining plate on the front side | 12. Ventilation holes (air exhaust) |
| 5. D1, D2, D3 and D4 : Drives (stacked one above the other in a drive cage) | 13. Slots for expansion cards with fastening screw. |
| 6. Card hold down bracket (for long expansion cards) | 14. ATX Mainboard |
| 7. Card hold down bracket (for short expansion cards) | 15. Fastening screw for the card hold down bracket (internal accessible) |
| 8. Retaining bracket for the card hold down bracket | 16. Card guides (for full-length cards) |
| | 17. Optional 3.5" drive bay (breakout on front panel) |
| | 18. Fan compartment (containing fan assembly) |

4.5.2. System Configuration KISS 4U V3 SKW

Figure 23: Example of KISS 4U V3 SKW configuration with ATX mainboard (SKW)

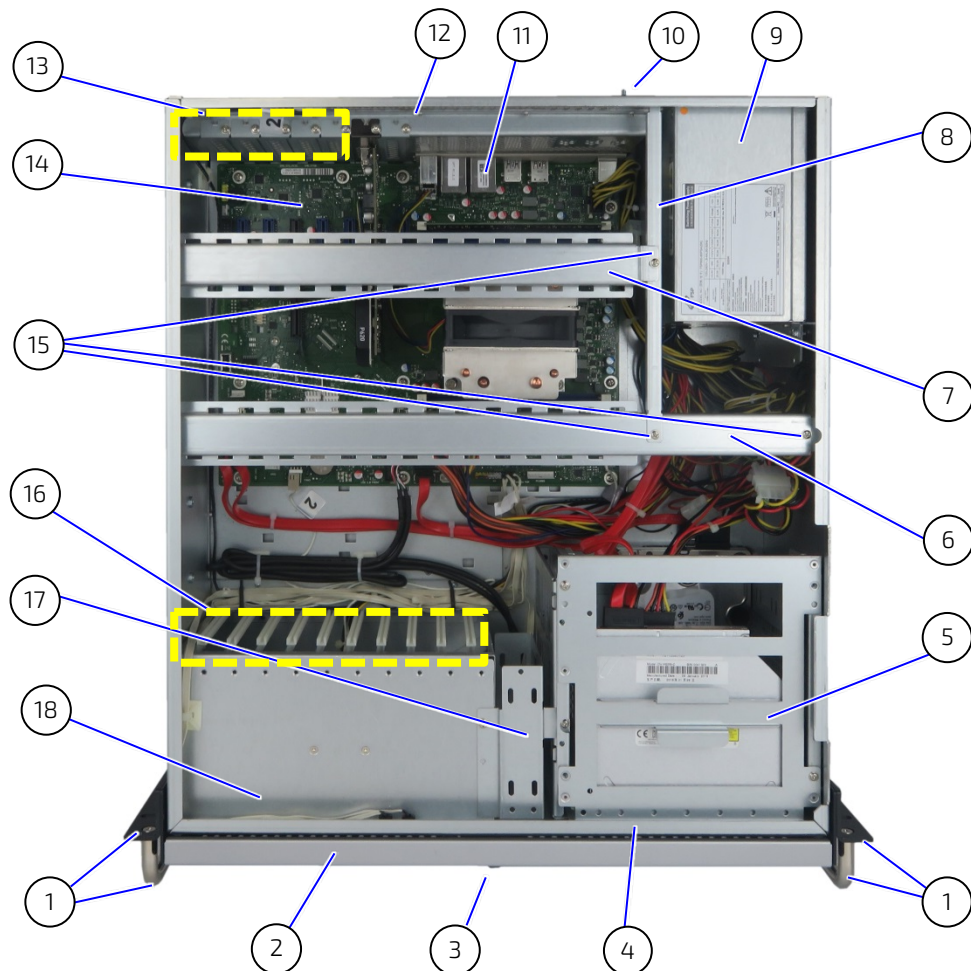

- | | |
|--|--|
| 1. 19" rack mountable bracket with handle | 9. Power supply unit (PSU) |
| 2. Front access panel | 10. Potential equalization stud |
| 3. Access panel lock | 11. External interfaces of the mainboard |
| 4. Cover retaining plate on the front side | 12. Ventilation holes (air exhaust) |
| 5. D1, D2, D3 and D4: Drives (stacked one above the other in a drive cage) | 13. Slots for expansion cards with fastening screw |
| 6. Card hold down bracket (for long expansion cards) | 14. ATX Mainboard |
| 7. Card hold down bracket (for short expansion cards) | 15. Fastening screw for the card hold down bracket (internal accessible) |
| 8. Retaining bracket for the card hold down bracket | 16. Card guides (for full-length cards) |
| | 17. Optional 3.5" drive bay (breakout on front panel) |
| | 18. Fan compartment (containing fan assembly) |

4.5.3. System Configuration KISS 4U V3 PCI763

Figure 24: Example of KISS 4U V3 PCI763 configuration with PICMG 1.3 (full-size) SBC

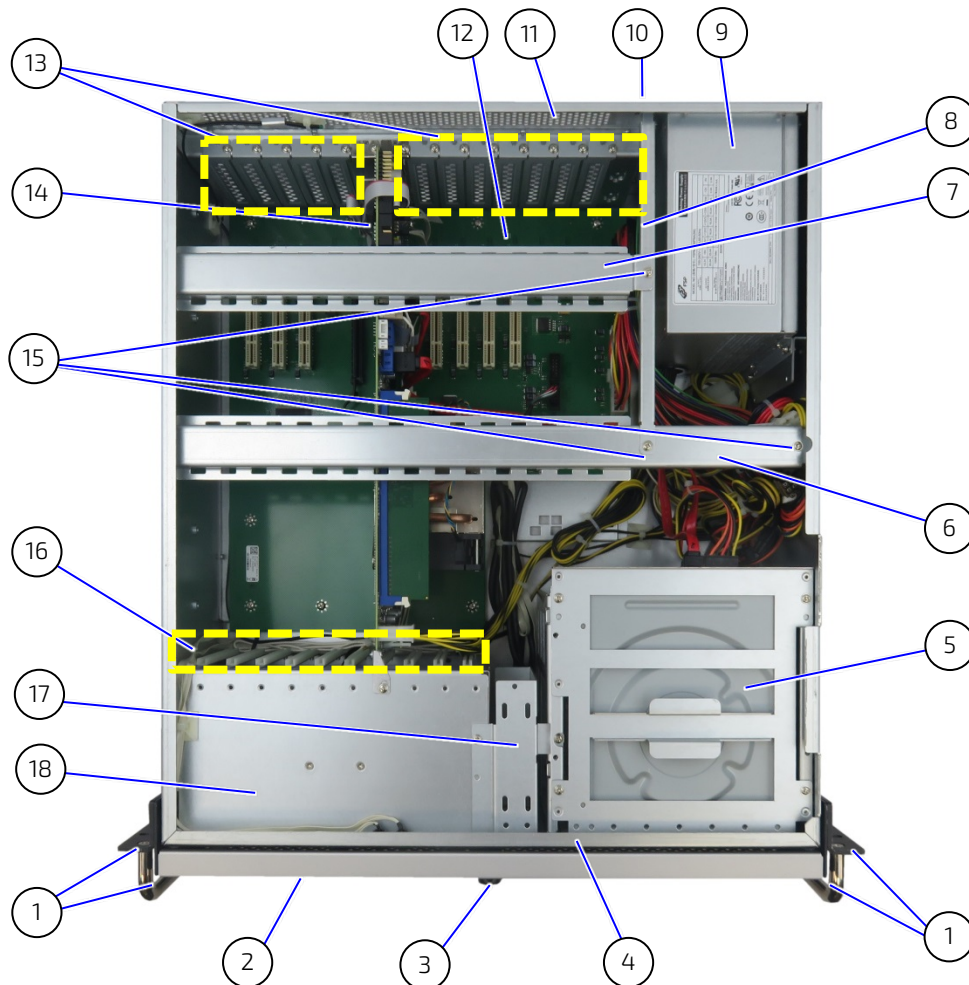

- | | |
|---|--|
| <ol style="list-style-type: none"> 1. 19" rack mountable bracket with handle (remove on desktop version) 2. Front access panel 3. Access panel lock 4. Cover retaining plate on the front side 5. D1, D2, D3 and D4: Drives (mounted on top of each other in a drive cage). 6. Card hold down bracket (for long expansion cards) 7. Card hold down brackets (for short expansion cards) 8. Retaining bracket for Card hold down bracket | <ol style="list-style-type: none"> 9. Power supply unit (PSU) 10. Potential equalization stud 11. Ventilation holes (air exhaust) 12. Backplane 13. Free Slots for expansion cards (7x PCI, 5x PCIe 2.0) with fastening screw 14. PICMG1.3 (Full size) SBC 15. Fastening screws for the card hold down bracket (internal accessible) 16. Card guides (for full-length cards) 17. Optional 3.5" drive bay (breakout on front panel) 18. Fan compartment (containing fan assembly) |
|---|--|

5/ System Extension



Due to the limited lifespan of expansion devices, Kontron recommends checking the condition of installed expansion devices regularly and to pay attention to the manufacturer's lifespan specifications.

5.1. Mass Storage Options

For KISS 4U V3 CFL and KISS 4U V3 SKW additional storage is available using the mainboard's M.2 slot, to install a M.2 2280 memory module. Raid support is not available for the on-board M.2 memory module.

Table 5: Mass storage devices

Mass Storage Device	Description
On-board M.2 slot	M.2 2280 (PCIe 4 lanes) SSD module ^[1]

^[1] Option for the KISS 4U V3 CFL and KISS 4U V3 SKW variants.



Raid support is not available for the on-board M.2 memory module.

5.2. Expansion Cards

For the KISS 4U V3 CFL, KISS 4U V3 SKW and KISS 4U V3 PCI763 additional functionality can be installed using PCIe and PCI expansion cards. For information regarding the supported PCIe and PCI cards, see Table 6: Expansion slots.

Table 6: Expansion slots

Installed Mainboard	Expansion Card Type	
	PCIe	PCI
ATX (CFL)	5x PCIe (full height, full length) ^[1] Slot 1: PCIe x16 Gen3 (16 lanes) Slot 2: PCIe x1 Gen3 (open) Slot 3: PCIe x16 Gen3 (4 lanes) Slot 4: PCIe x8 Gen3 (1 lanes) (open) Slot 5: PCIe x8 Gen3 (1 lanes) open	2x PCI (full height, full length) Slot 6: PCI 1 32-bit Slot 7: PCI 2 32-bit
ATX (SKW)	7x PCIe (full height, full length) Slot 1: PCIe x8 Gen 3 (4 lanes) Slot 2: PCIe x8 Gen 3 (1 lanes) Slot 3: PCIe x16 Gen 3 (16 lanes) Slot 4: PCIe x8 Gen 3 (4 lanes) Slot 5: PCIe x8 Gen 3 (1 lanes) Slot 6: PCIe X16 Gen 3 (16 lanes) Slot 7: PCIe x8 Gen 3 (8 lanes)	
PICMG 1.3 backplane (full-size) SBC	1x PCIe 2.0 x16 (16 lanes) (full height, full length) 1x PCIe 2.0 x4 (4 lanes) (full height, full length) 3x PCIe 2.0 x1 (1 lane) (full height, half length)	4x PCI 32-bit (full height, full length) 3x PCI 32-bit (full height, half length)

Figure 25: PCIe/PCI expansion slots type and location – PICMG 1.3 backplane SBC variant

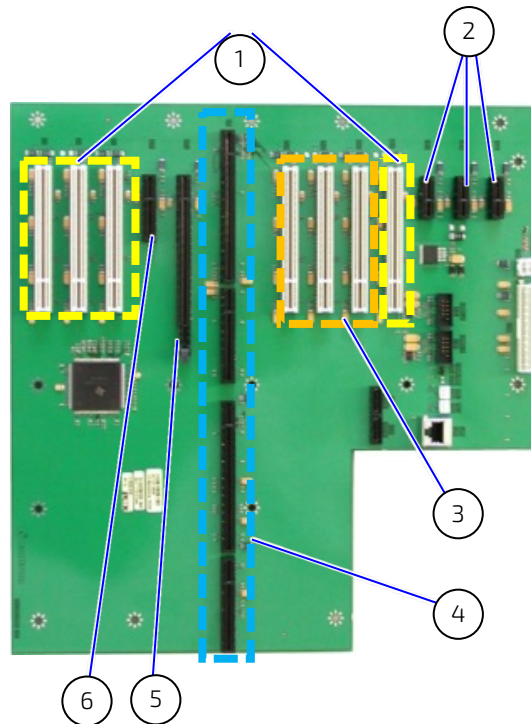

- | | |
|--|--|
| 1. 4x PCI 32-bit (full height, full length) | 4. 1x PICMG 1.3 (full-size) SBC slot.
(This slot is not available for expansion cards.) |
| 2. 3x PCIe 2.0 x1 (full height, half length) | 5. 1x PCIe 2.0 x16 (full height, full length) |
| 3. 3x PCI 32-bit (full height, half length) | 6. 1x PCIe 2.0 x4 (full height, full length) |



For PCIe/PCI slot functionality and location information, refer to the manufacturer's "Product Information". For the mainboard name and type, see Chapter 11.2: Technical Specification.



Before extending the product with expansion cards consider the maximum power consumption allowed by the PSU

6/ Thermal Considerations

6.1. Active Cooling

The KISS 4U V3 is forced air-cooled using two internal system fans that force air to flow from the front to the back of the chassis. The processor and expansion cards have integrated cooling solutions or are equipped with corresponding cooling devices. If a filter pad is used, clean the filter pad regularly to ensure that sufficient airflow is provided, see Chapter 10.1: Cleaning the Filter Pad.

6.2. Temperature Sensor

The temperature conditions of the product (depending on the environmental temperature and the load) are detected by two internal temperature sensors (one at the rear and one near the fan assembly) that control the speed of the system fans within the fan assembly accordingly.

6.3. Minimum System Clearance

To guarantee that sufficient air flows from the front to the back of the chassis, ensure that the ventilation holes are not covered, blocked or obstructed by surrounding parts.

Before installing the KISS 4U V3 take into account, any thermal considerations mentioned in Chapter 8/Installation, such as airflow obstructions and the correct mount orientation.

⚠ WARNING

Ensure Sufficient Airflow

Ensure that the 19" rack cabinet is well ventilated and does not prevent the KISS 4U V3 from taking in air at the front and exhausting air at the rear.

⚠ WARNING

Do not place the product close to heat sources or damp places.



There are no ventilation restrictions above and below the product, enabling installation directly on top of or below another system.

6.4. Third Party Components

When the KISS 4U V3 is extended and configured with third party components such as PCIe expansion cards, M.2 module, DIMMs and drives (HDD, SSD, DVD), there is an internal temperature rise. Thus, the air temperature inside the product is higher than the ambient temperature around the product.

7/ Assembly

No special tools are required, to assemble the KISS 4U V3. Before opening the KISS 4U V3 observe the instructions within this chapter.

⚠ WARNING

Energy hazards-240 VA present inside the chassis!

Before removing the top cover. Switch off the product properly using the power switch on the front side and disconnecting the power cable from the mains power supply.

⚠ WARNING

Recommended intended used is closed and locked

Only when the cover is secured is it ensured that the operator does not have access to the internal parts, loaded with hazardous energy. To close properly secured using all knurled screws: one front side and two rear side.

7.1. Opening and Closing the Cover

To open the cover, proceed as follows:

1. Switch off and disconnect the system from the mains power supply.
2. Loosen the cover's knurled screws on the front side (Figure 26) and the two knurled screws on the rear side (Figure 27) that secure the cover.

Figure 26: Loosening knurled screw on the front side



Figure 27: Loosening knurled screw on the rear side



3. Pull the cover out slightly as shown in Figure 28 to release the cover's centering and fixing brackets (Figure 21, pos.3 and pos. 4) from the retaining brackets of the chassis (Figure 22, pos. 4).

Figure 28: Pull and release the cover



4. Lift the cover up (on the rear edge) and remove the cover as shown in Figure 29.

Figure 29: Removing the cover



5. To close and secure the cover, proceed in the reverse order (step 4 to step 2).

⚠WARNING

To close properly secure using all knurled screws: one front side and two rear side

7.2. Accessing Internal Components

This chapter contains important information on working safely with internal components. Follow these instructions when handling internal components and observe the corresponding safety instruction included in Chapter 1/: General Safety Instructions for IT Equipment.

⚠ WARNING

Energy hazards-240 VA present inside the chassis!

Before removing the top cover. Switch off the product properly using the power switch on the front side and disconnecting the power cable from the mains power supply.

⚠ WARNING

Activities requiring internal access of the product must be performed by trained personnel aware of the associated dangers!



ESD Sensitive Device!

Follow the safety instructions for components that are sensitive to electrostatic discharge (ESD). Failure to observe this warning notice can result in damage to the components.



Consult the documentation provided by the expansion card's manufacturer for instructions before installing/removing an expansion card.

7.2.1. Installing and Removing Expansion Cards

The expansion cards are secured using the expansion cards front bracket, on the rear side for long expansion cards and by the card hold down brackets. (Figure 30) using a PCB holder. To install or remove expansion cards the card hold down brackets must be removed from the chassis.



To install short expansion cards (half length), only the card hold down bracket for short expansion cards (Figure 22, pos. 7) must be removed.

To install or remove an expansion card, perform the following steps:

1. Switch off and disconnect the product from the mains power supply.
2. Open the cover as described in Chapter 7.1: Opening and Closing the Cover.
3. Locate the long and short card hold down brackets (Figure 22, pos. 6, pos. 7) and the retaining bracket (Figure 22, pos. 8) within the product, that secure the expansion cards to the corresponding expansion slots.

Figure 30: Card hold down bracket for short and long expansion cards and expansion card PCB holder

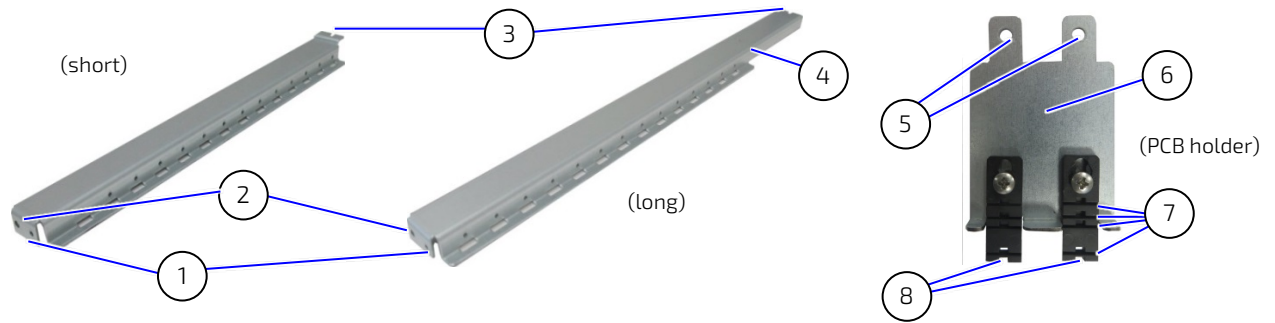

- | | |
|---|---|
| <ol style="list-style-type: none"> 1. Threaded holes for the externally accessible fastening screws (Figure 19, pos. 5 & 7) 2. Holes for internal bolts (Figure 19, pos. 4 & 6) 3. Notches for fastening screws to secure card hold down brackets to the internal brackets 4. Threaded hole to attach retaining bracket | <ol style="list-style-type: none"> 5. Screw holes to fasten to card hold down bracket 6. Metal bracket to fasten to card hold down bracket 7. PCB holder (with adjustable break off ridges) 8. PCB holder notch |
|---|---|

4. To remove the card hold down bracket for short expansion cards:
 - a. Loosen the internal and then the externally accessible fastening screw that secure the card hold down bracket for short expansion cards (Figure 22, pos. 7), (Figure 31, Number 1 and 2).
 - b. Pull the card hold down bracket to the left (Figure 31, Number 3) to detach the card hold down bracket from the sideways mounted bolts.
 - c. Lift the card hold down bracket out (Figure 31, Number 4) and retain for later use.

Figure 31: Steps to remove/install the card hold down brackets

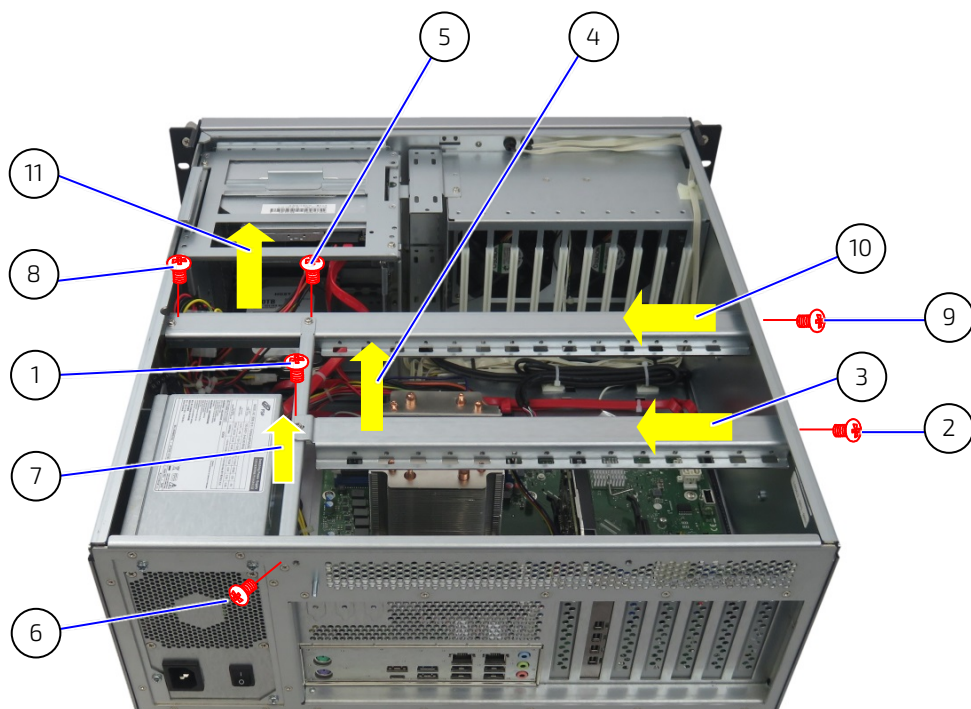

5. To remove the retaining brackets:
 - a. Loosen the internal and then the externally accessible fastening screw that secure the retaining bracket (Figure 22, pos. 8), (Figure 31, Number 5 and 6).
 - b. Lift the retaining bracket out (Figure 31, Number 7) and retain for later use.
6. To remove the card hold down bracket for long expansion cards:
 - a. Loosen the internal and then the externally accessible fastening screws that secure the card hold down bracket for long expansion cards (Figure 22, pos. 6), (Figure 31, Numbers 8 and 9).
 - b. Pull the card hold down bracket to the left (Figure 31, Number 10), to detach the card hold down bracket from the side mounted bolts.
 - c. Lift the card hold down bracket out (Figure 31, Number 11) and retain for later use.
7. Install/remove the expansion card into/from expansion slot of the backplane or mainboard and fasten the expansion card bracket or slots bracket on the rear side of the chassis (Figure 22, Figure 23, Figure 24, pos. 13).
8. Reinstall the card hold down bracket/s and, if applicable retaining bracket with the screws retained in steps 4, 5 and 6 and proceeds in the reverse order by:
 - a. Initially, tighten the screws half way only.
 - b. Then, firmly tighten the externally accessible screws (Figure 31, Numbers. 9, 2 and 6)
 - c. Finally, firmly tighten the screws at the notches that secure the card hold down brackets. (Figure 31, Numbers 1, 5 and 8)
9. To keep expansion card firmly in place during high mechanical load (shock and vibrations) PCB holders (Figure 30) are used to stabilize the expansion cards (especially long expansion cards).
To install or remove a PCB holder:
 - a. Fix the upper edge of the expansion card (especially with long expansion cards) into the required notch of the PCB holder (Figure 30, pos. 8) by adjusting the PCB holder's height by break of the unrequired ridges of the plastic notch strip.
 - b. Securely fasten the PCB holder (Figure 30, pos. 5) to the card hold down bracket.
 - c. To remove the PCB holder proceed in the reverse order by first releasing the PCB holder from the card hold down bracket and then releasing the PCB holder's notch (Figure 30, pos. 8) from the top side of the expansion card.
10. Close the KISS 4U V3 chassis by closing the cover as described in Chapter 7.1: Opening and Closing the Cover.

8/ Installation

The KISS 4U V3 is designed for horizontal installation in a 19" industrial rack cabinet with the top cover facing upwards. There are no ventilation holes on the top and bottom side of the product, enabling installation directly on top of or below other systems in the 19" industrial rack cabinet. Due to possible access restrictions Kontron recommends installing all expansion cards and connecting all peripherals to the corresponding system ports before installing in the end environment.

Before installing or removing the KISS 4U V3 in a 19" industrial rack or desktop environment, read the general installation instructions within this chapter and observe the information in Chapter 1/:General Safety Instruction for IT Equipment.

⚠ WARNING

The product must be installed only by trained personnel aware of the associated dangers.

⚠ WARNING

Ensure sufficient air circulation

Ensure the KISS 4U V3 is well ventilated and that nothing obstructs the KISS 4U V3 from taking in air at the front and exhausting air at the rear.

⚠ WARNING

Do not place the product close to heat sources or damp places.

⚠ CAUTION

Before connecting any I/O cables. Ensure that the product is switched off and the power cable is disconnected connected from the power connector or mains power.

⚠ CAUTION

When connecting cables, following proper cabling procedures:

1. Grounding pin is connected first and disconnected last
2. Connect all I/O cables
3. Power connection is the last connection



The KISS 4U V3 is designed for horizontal operation. Vertical operation is possible.



Due to possible access restrictions, before installing the product install all expansion cards and connect required peripherals to the corresponding system port.

8.1. Installing the Rubber Feet

For use on a desktop, to avoid scratching the surface, attach the supplied four rubber feet:

1. Switch off the product and disconnect it from the mains power supply. Disconnect all peripherals.
2. Ensure that all cards are secured into unit and that the cover is installed and secured.
3. Turn the chassis upside down (Orientation bottom side facing upwards).
4. Remove the protective film from the self-adhesive rubber feet and attach to the bottom side of the chassis.
5. Turn the chassis the right way around (Orientation: cover facing upwards).

8.2. Removing the Handle Brackets

The two handles brackets are removable. To remove the two handles brackets, proceed as follows:

1. Loosen and remove the two screws (Figure 8, pos. 4) that fasten the handle brackets (left side, right side).
2. Remove the handle bracket and store with fastening screws for possible further use.
3. To reinstall the handle brackets proceed in the reverse order (step 1 to 2).



The KISS 4U V3 is delivered with the handle brackets already assembled.

8.3. Removing the Front Access Panel and Front Access Panel Side-Plates

The front access panel and the two front access panel side-plates are removable.

Figure 32: Front access panel side-plate and handle bracket

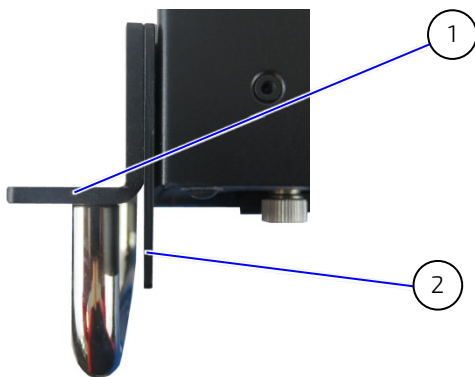

1. Bracket handle
2. Front access panel side-plate

To remove the front access panel and front access side-plates, proceed as follows:

1. Remove the handle brackets as described in Chapter 8.2: Removing the Handle Brackets (steps 1-2) and retain the handle bracket and screws for future use.
2. Loosen the two screws that hold the front access panel side-plate to chassis (left side, right side).
3. When loosened enough the front access panels hinges can be removed from the front access panel side-plate's hole. Initially release one side and of the front access panel the other side will loosen and can be removed.
4. Guide the front access panel's holder arm out of holding slot (Figure 9, pos. 1).
5. Store the front access panel for future use.
6. Tighten the loosened fastening screws that hold the front panel side-plate in position.
7. Remove the front panel side-plates (left side and right side) by removing the two screws previously loosened in step 2
8. If required install the handle bracket as described in Chapter 8.2: Removing the Handle Brackets (step 3) using the screws removed in step 1.

8.4. Installation as a Desktop

Before installing the KISS 4U V3 in a desktop environment, install the rubber feet as described in Chapter 8.1: Installing the Rubber Feet, to avoid scratching the installation surface. Additionally, observe the general instructions and any safety warnings within this chapter.

⚠️ WARNING

Voltage feeds must not be overloaded

Adjust the cabling and the external overcharge protection to correspond with the electrical data indicated on the type label located on right side of the chassis.

⚠️ WARNING

Ensure sufficient air circulation

Ensure that nothing obstructs the KISS 4U V3 from taking in air at the front and exhausting air at the rear.

To install in a desktop environment, proceed as follows:

1. Add the rubber feet as described in Chapter 8.1: Installing the Rubber Feet.
2. If required, remove the handle brackets as described in Chapter 8.2 :Removing the Handle Brackets
3. If required remove the front access panel and two front access panel side-plates as described in Chapter 8.3: Removing the Front Access Panel and Front Access Panel Side-Plates.

8.5. Installing in a 19" Industrial Rack

Before installing the KISS 4U V3 in a 19" industrial rack, observe the instructions described in this chapter and any additional safety warnings. To assemble using slide rails, see Chapter: 8.6: Slide Rails (Option).

⚠️ WARNING

To support the KISS 4U V3's weight, two separate fixation methods must be used:

- ▶ Front handle brackets (right side and left side)
- ▶ Slide rails or L brackets or a 19" rack rear side fixation

⚠️ WARNING

Ensure Sufficient Airflow

Ensure that the 19" Industrial rack cabinet is well ventilated and does not prevent the KISS 4U V3 from taking in air at the front and exhausting air at the rear.

⚠️ WARNING

The 19" industrial cabinet must be stable. To improve stability:

- ▶ Install systems from the bottom up
- ▶ Place heavy systems lower down
- ▶ Bolt the cabinet to the floor or anchor the cabinet to the wall

⚠️ CAUTION

Installing the KISS 4U V3 alone can result in product damage or personal injury.

⚠️ CAUTION

Verify secure mounting

Mount using the slides rails on the left and right sides and ensure the front handle brackets are fastened to the left and right sides of the 19" Industrial rack cabinet.



Due to possible access restrictions, before installing the KISS 4U V3 install all expansion card and connect required peripherals to the corresponding system ports.

To install in a 19" industrial rack, proceed as follows

1. Install the slide rails to the KISS 4U V3 as described in Chapter 8.6: Slide Rails (Option).
2. Install the corresponding rail slide kits to the 19" industrial rack cabinet as shown in Figure 36: Assembling the slide rails in an industrial rack cabinet.
3. Push the KISS 4U V3 with slide rail assembly into the corresponding slide rail within the 19" industrial rack as far as possible and fasten at the rear of the 19" industrial rack cabinet.
4. Firmly attach the KISS 4U V3's handle bracket to the sides of the 19" industrial rack.
5. Verify that the KISS 4U V3 is securely mounted.

8.6. Installing Slide Rails (Option)

Kontron offers compatible 19" Slide Rails and Rack Slide Rails Kit for the KISS 4U V3. For more information, see Table 2: Accessories and spares parts.

⚠ WARNING

To support the KISS 4U V3's weight, two separate fixation methods must be used:

- ▶ Front handle brackets (right side and left side)
- ▶ Slide rails or L brackets or a 19" rack rear side fixation

⚠ CAUTION

Use only the specified screws to attach telescope slide rails to the KISS 4U V3.

⚠ CAUTION

Verify secure mounting

Mount using the slides rails on the left and right sides and ensure the front handle brackets are fastened to the left and right sides of the 19" Industrial rack cabinet.

To install slide rails, proceed as follows:

1. Extend the slide rail to the pulled-out position to expose the inner part of the slide rail (Figure 33) with screw holes (Figure 33, pos. 2).
2. Using the supplied screws firmly attach the side rail to the left side and right side. (Figure 33, pos. 2).
3. Push the slide rail into the pushed-in position (Figure 35).
4. Install the corresponding rack slide rail kits to the 19" industrial rack cabinet, see Figure 36: Assembling the slide rails in an industrial rack cabinet.

Figure 33: Slide rail inner part to a KISS 4U V3 chassis

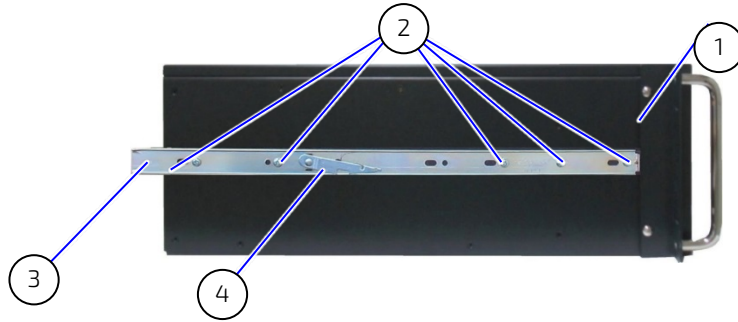

Figure 34: Slide rail in pulled-out position

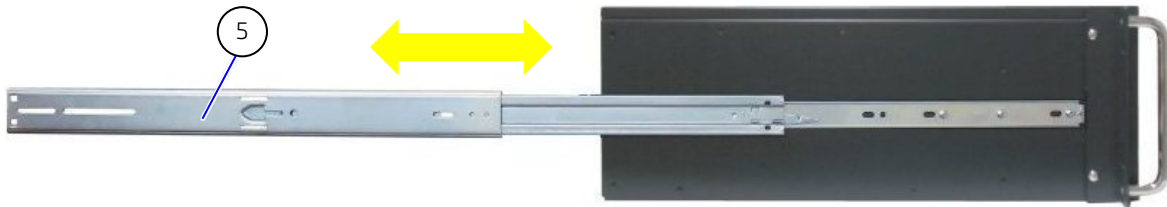

Figure 35: Slide rail in pushed-in position



Legend for Figure 33, Figure 34 and Figure 35

- | | |
|---|--------------------------------------|
| 1. Side view of the KISS 4U V3 | 4. Locking/unlocking lever |
| 2. 6x M4 rounded head screws(per each side) | 5. Slide rail in pulled-out position |
| 3. Inner part of the slide rail | 6. Slide rail in pushed-in position |

Figure 36: Assembling the slide rails in an industrial rack cabinet

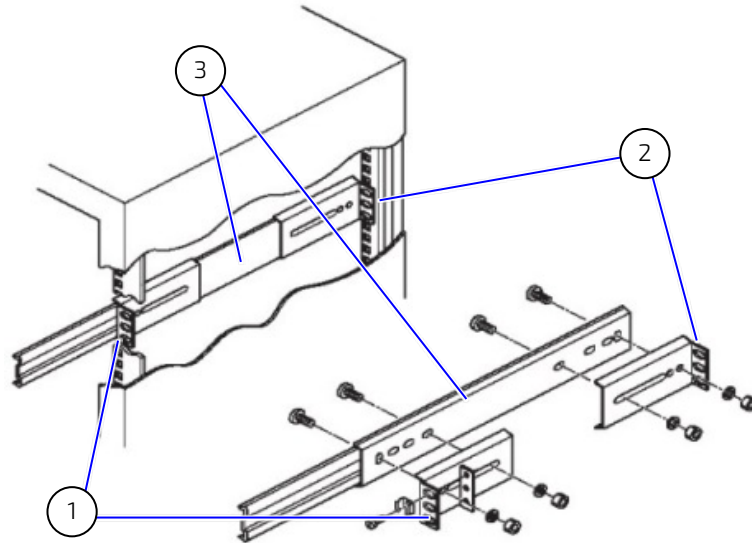

1. Short front bracket
2. Long rear bracket
3. Telescopic slide rail attached to Industrial rack cabinet



Short brackets are usually used at the front of the chassis and long brackets at the rear.

9/ Starting Up

Before starting up observe the instructions in Chapter 1: General Safety Instruction for IT Equipment.

⚠ WARNING

Easy Access to Power Cable and Power Connectors

The power cable must always remain easily accessible. If the end environment restricts access to power cable, disconnection must be guaranteed using a separate cut-off fixture.

⚠ WARNING

Energy hazards-240 VA present in the chassis

To switch off the product properly and ensure no energized internal parts, switch off the product using the power switch on the front side and disconnecting the product's power cable from the input power socket or the mains power supply.

⚠ WARNING

Intended used is closed

Use only when the cover is closed using the kurnled screws (one front side and two rear side) to ensured that the operator doesn't have access to energized internal parts.

⚠ CAUTION

Ensure that the mains power supply socket (power outlet) is properly grounded and the power cable is in perfect condition with no visible damage.

⚠ CAUTION

The rated mains voltage range must agree with the voltage specified on the type label.

9.1. Connecting the Power Connection

The input power socket is located on the rear side. To connect the power and start up, proceed as follows:

1. Connect the ends of the supplied AC power cable to the corresponding sockets:
 - a. Input power socket (Figure 37)
 - b. Mains power supply socket using the electrical plug for the region.

Figure 37: Input power socket

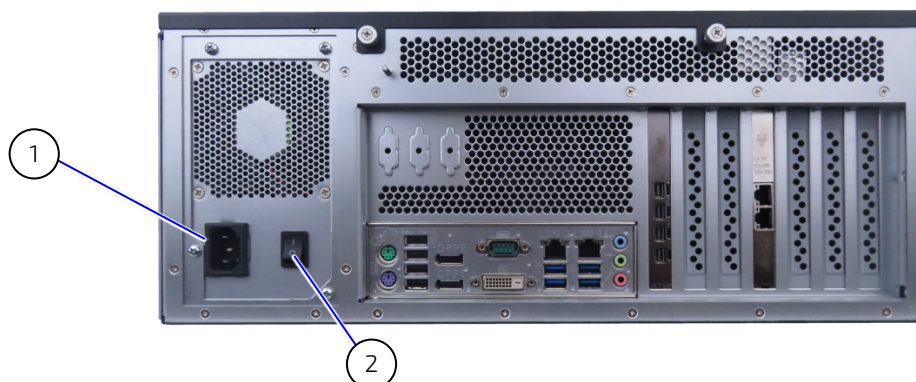

1. Input power socket

2. On/Off PSU switch (single PSU only)

3. Unlock the front access panel (Figure 7, pos. 5) and press the power button (Figure 9, pos. 3).

4. Close and lock the front access panel.
5. The power LED illuminates green (Figure 7, pos. 6 and Figure 11, pos. 1).

NOTICE

**Do not disconnect the power from the product while the product is powered up!
Performing a forced shut down can lead to loss of data or other undesirable effects!**

9.2. Operating System and Hardware Component Drivers

The KISS 4U V3 is fully operational when switched on for the first time with pre-installed Operating System (OS) Windows 10 IoT x64 or Linux and with all required drivers. Drivers are available from Kontron's EMD customer section.

If ordered without pre-installed OS, before starting the KISS 4U V3 install the OS and the appropriate drivers for the system configuration. Consider the manufacturer's specifications for the OS and the integrated hardware components.



Download relevant drivers for the installed hardware by visiting Kontron's EMD Customer Section: <https://www.kontron.com/support-and-services/support/customer-section>.



Pay attention to the installed hardware components manufacturer's OS specification.

10/ Maintenance and Prevention

Kontron Europe systems only require minimal maintenance and care to keep them operating correctly.

- ▶ Wipe the product with a soft dry cloth if required
- ▶ Remove persistent dirt by use of a soft, slightly damp cloth (only use a mild detergent).
- ▶ Clean the air filter pad regularly (as often as necessary, depending on the environment)

10.1. Cleaning the Filter Pad

The removable filter pad inserts in the filter pad holder on the front side of the fan assembly. The filter pad is soiled by pollution within the operating environment. If heavily soiled, the filter pad can cause excessive heating of the product. Kontron recommends cleaning the filter pad as often as necessary. The filter pad can be changed during operation.

Figure 38: Front side with filter pad holder

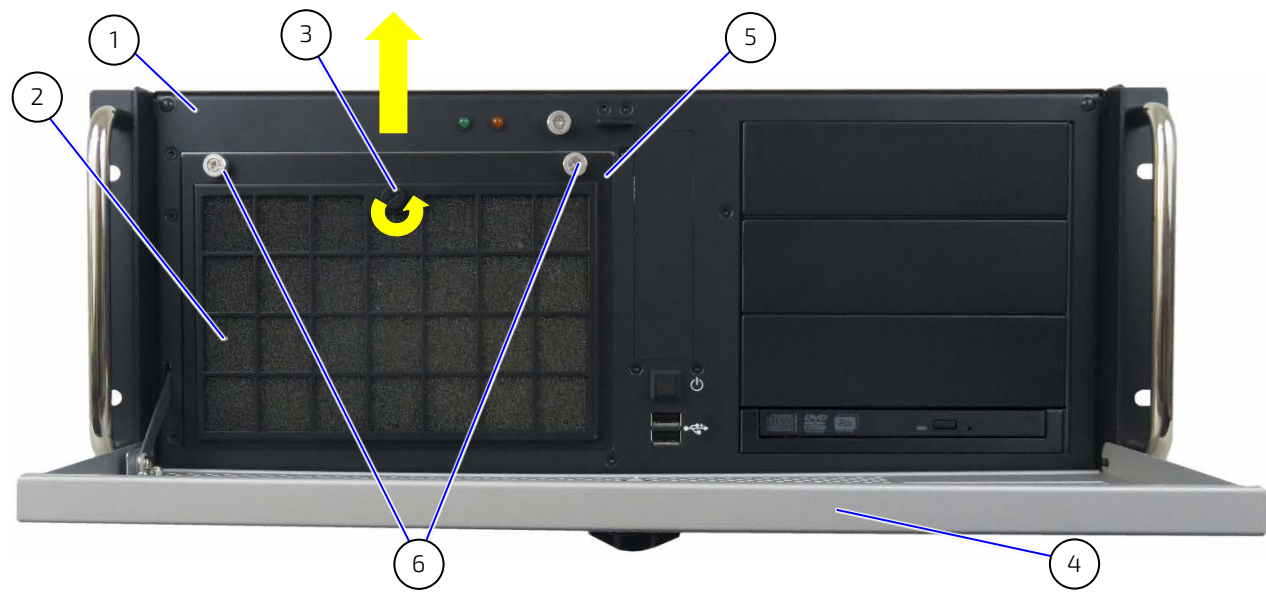

- | | |
|---|--------------------------------------|
| 1. Front side | 4. Front access panel |
| 2. Filter pad | 5. Fan assembly |
| 3. Filter pad holder with knurled screw | 6. Fan assembly's two knurled screws |

CAUTION

Operation is permitted only with a functional fan assembly!
Replace a defective fan assembly only with an original fan assembly.

To replace the filter pad, proceed as follows:

1. Open the front access panel (Figure 38, pos. 4).
2. Loosen the knurled screw that secures the filter pad holder to the fan assembly (Figure 38, pos. 3)
3. Release the filter pad holder's positioning latch from the from the positioning holes on the fan assembly (Figure 38, pos. 3) by moving upwards and lifting out the filter pad holder.
4. Remove the dirty filter pad (Figure 42) from the filter pad holder (Figure 40).

5. Clean the filter pad as follows:
 - a. Rinse in water (up to approx. 40°C/104°F; with a mild commercial detergent).
 - b. It is also possible to beat the filter pad, suction clean the filter pad or blast the filter pad with warm compressed air.
 - c. If the filter is soiled with grease and dust, rinse the filter pad in warm water with a degreaser
 - d. Do not clean the air filter pad with a piercing jet of water.
6. Do not wring out the filter pad, allow the filter pad to air dry
7. After cleaning and drying the filter pad, place the filter pad in the filter pad holder.
8. Reattach the filter pad holder to the front side of the fan assembly by inserting the filter pad holder's positioning latches (Figure 40, pos. 7) into the fan assembly's positioning holes (Figure 39, pos. 3).
9. Fasten the filter pad holder by tightening the knurled screw (Figure 40, pos. 5) to the bolt with tapped hole (Figure 39, pos. 1) on the fan assembly.

Figure 39: Fan assemble without filter pad holder

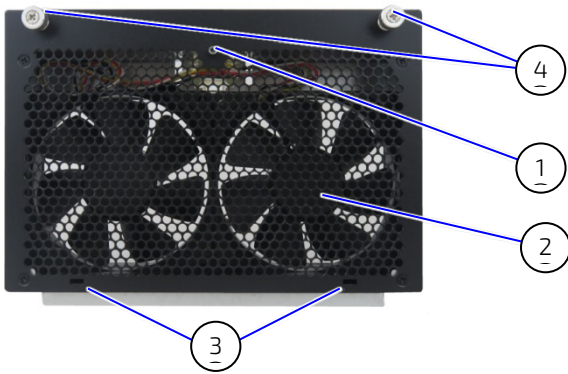

Figure 40: Filter pad holder (without filter pad)

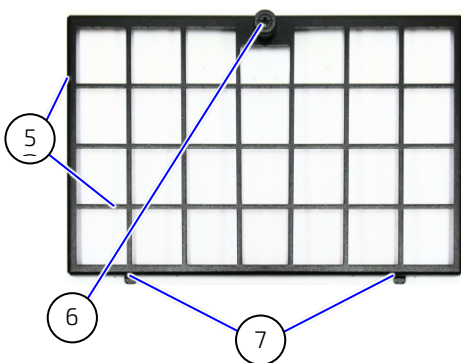
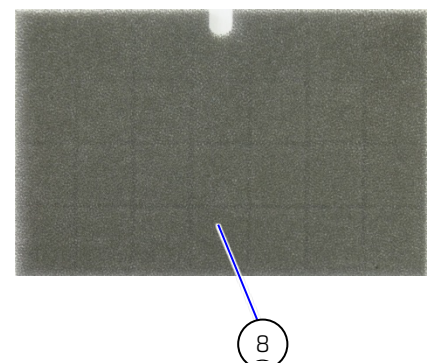

Figure 41: Filter pad holder (with filter pad)



Figure 42: Filter pad



Legend for Figure 39, Figure 40, Figure 41 and Figure 42

- | | |
|--|--|
| 1. Fan assembly bolt with tapped hole | 5. Filter pad holder |
| 2. Ventilation holes (air intake) | 6. Filter pad holder Knurled fastening screw |
| 3. Positioning holes for the filter pad holder | 7. Filter pad holder positioning latches |
| 4. Knurled screws to fix fan assembly to chassis | 8. Filter |

10.2. Replacing the Fan Assembly

Before replacing the fan assembly, read the following instructions:

⚠ CAUTION

Operation is permitted only with a functional fan assembly!
Replace a defective fan assembly only with an original fan assembly.

⚠ CAUTION

Fan assembly replaceable during operation
Replace fan only by qualified specialist or a suitably instructed persons aware of the associated dangers. Before removing the fan assembly, wait until the fans have totally stopped. Keep hands and fingers away from rotating fan parts.



The filter pad holder can be fastened to the front side of the fan assembly either before or after the fan assembly is installed in the chassis.

To replace the fan assembly, proceed as follows:

1. Remove the filter pad holder and filter pad as described in the Chapter 10.1: Cleaning the Filter Pad (step 1 to 3). Retain the filter pad holder and filter pad for later use.
2. Loosen the two knurled screws of the fan assembly (Figure 43).
3. Pull the fan assembly slightly upwards to free the fan assembly from the internal fixing plate (Figure 44, pos. 1) and outwards to disconnect the fan assembly connector from the internal fan control socket (Figure 44, pos. 2).
4. Lift the assembly upwards to remove the fan assembly from the fan compartment (Figure 44, pos. 3).

Figure 43: Removing the fan assembly



Figure 44: Fan compartment (without fan assembly)

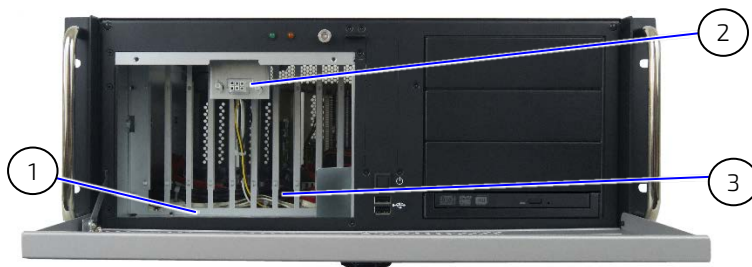

1. Fixing plate for the fan assembly
2. Fan power and control socket
3. Fan compartment

5. To replace with a new functional fan assembly, align the fan assembly with the fan compartment.

6. Insert the fan assembly's positioning bracket (Figure 12, pos. 5) into the fan compartment's fixing plate (Figure 44, pos. 1).
7. Push the fan assembly carefully into the fan compartment until the fan assembly's control connector (Figure 12, pos. 2) is firmly inserted into the internal fan power and control socket (Figure 44, pos. 2).
8. Secure the fan assembly by fasten the two knurled screws on the fan assembly, as shown in Figure 43.
9. Insert the filter pad into the filter pad holder (both retained in step 1). Then reattach the filter pad holder to the front side of the fan assembly as described in Chapter 10.1: Cleaning the Filter Pad (step 7 to 9).

10.3. Replacing the Faulty Redundant PSU

If one of the PSUs fails, the faulty PSU shuts down and generates a buzzing tone. Additionally, the indication LED changes color from green (active) to red (faulty). The functional PSU takes over the full operation of the KISS 4U V3 until the faulty PSU is replaced.

To replace the faulty PSU, proceed as follows:

1. Locate the faulty PSU with the red indication LED.
2. Remove the faulty PSU's power cable by pushing the cable holder slightly to the side and pulling out the power connector.
3. Pull the faulty PSU's handle to remove the faulty PSU.
4. Insert the replacement PSU.
5. Insert the power cable remove in step 2 into the replacement PSU's connector until the cable holder clicks to indicate that the cable is firmly in place.
6. Check that the indication LED light is green to indicate active operation.

10.4. Replacing the Lithium Battery

CAUTION

CAUTION: Risk of Explosion if the lithium battery is replaced by an incorrect type. Dispose of used lithium batteries according to the Instructions.

ATTENTION: Risque d'explosion si la pile au lithium est remplacée par une pile de type incorrect. Éliminez les piles au lithium usagées conformément aux instructions.



Do not dispose of lithium batteries in general trash collection. Dispose of the battery according to the local regulations dealing with the disposal of these special materials, (e.g. to the collecting points for dispose of batteries).

To replace the lithium battery on the main board, proceed as follows:

1. Switch off and disconnect the product from the mains power supply.
2. Open the cover, as described in the Chapter 7.2.1: Installing/Removing Expansion Cards (steps 1-4).
3. If the product includes expansion cards, first remove the expansion cards and all corresponding connecting cables, to gain access to the lithium battery, see Chapter 7.2: Accessing Internal Components.
4. Remove the lithium battery from the holder by pulling the ejector spring outwards.
5. Place a new lithium battery in the battery holder.

6. Pay attention to the polarity of the battery.
7. Replaced the lithium battery only with the same type of battery or with a type of battery recommended by Kontron.
8. Reinstall the removed expansion cards and re-attach the connecting cables,
9. Close the cover, as described in the Chapter 7.1: Opening and Closing the Cover.(step 5)

11/Technical Data

The main technical specifications of the KISS 4U V3 are listed within this chapter

11.1. Block Diagrams

Figure 45: Block diagram KISS 4U V3 CFL

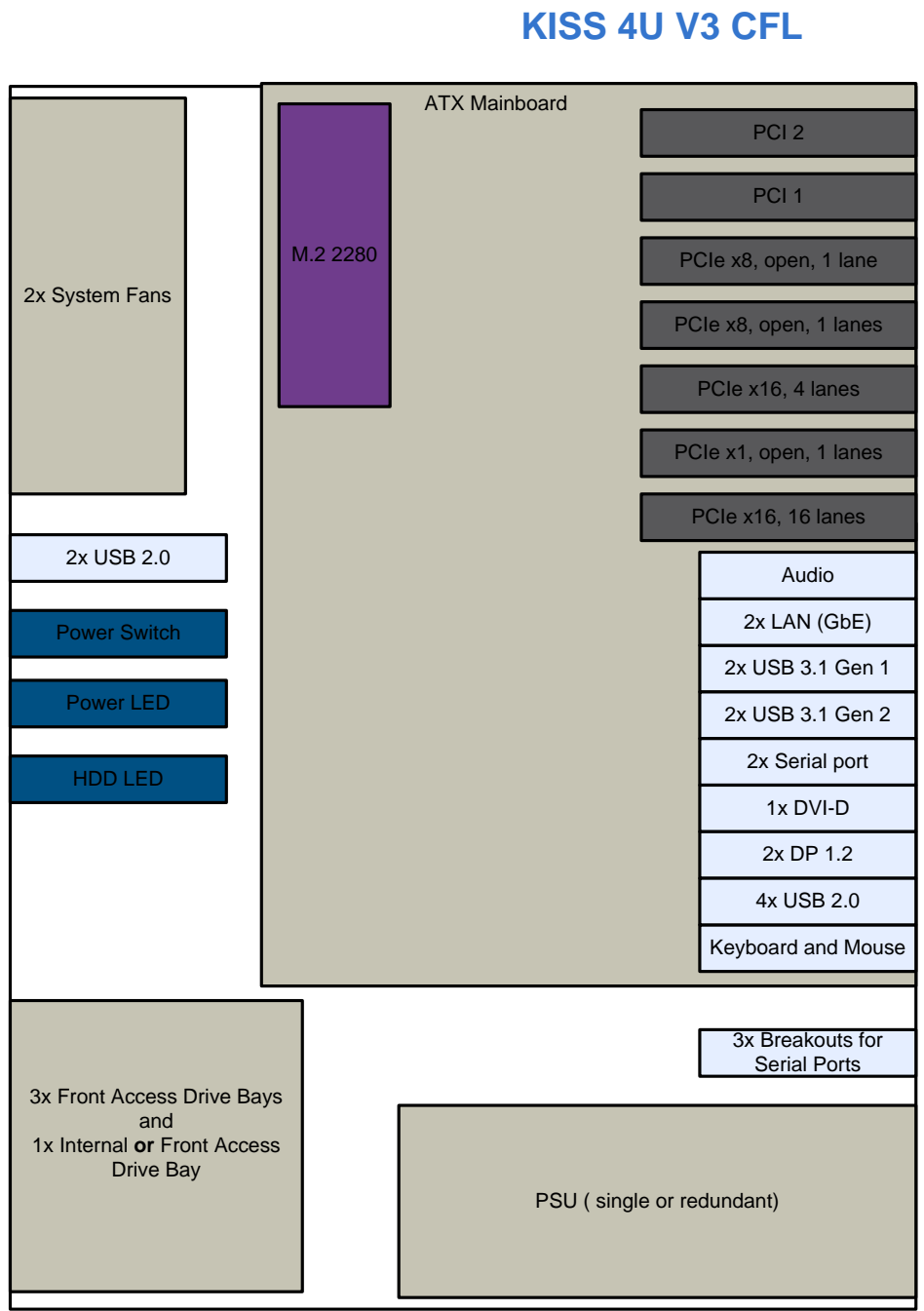

Figure 46: Block diagram KISS 4U V3 SKW

KISS 4U V3 SKW

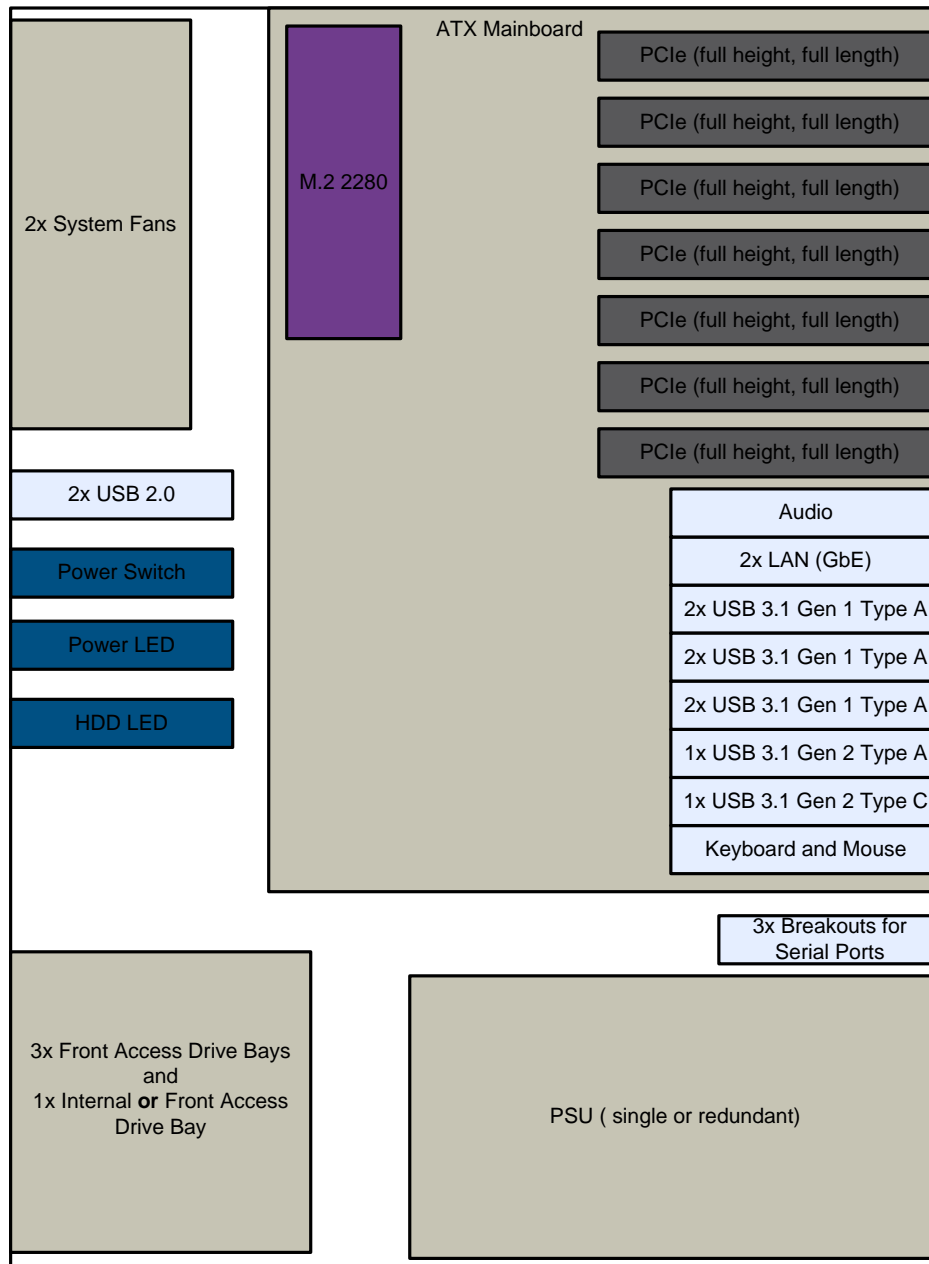
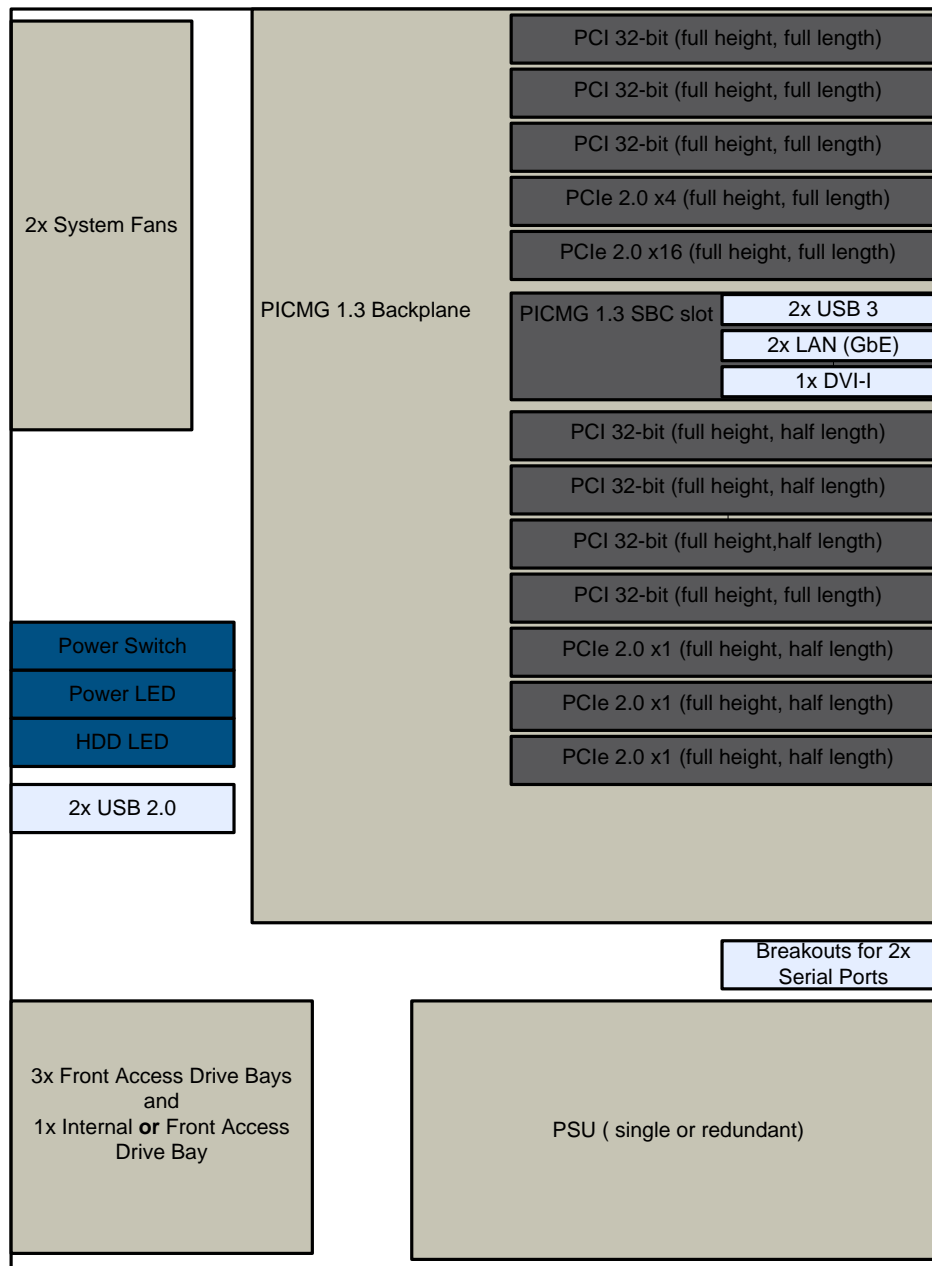
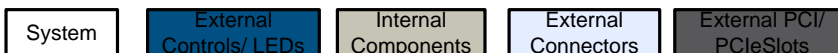

Figure 47: Block diagram KISS 4U V3 PCI763

KISS 4U V3 PCI763



Legend



11.2. Technical Specification

	KISS 4U V3 CFL		KISS 4U V3 SKW		KISS 4U V3 PCI763	
Mainboard						
Board	D3646-S (ATX)		D3598-B (ATX)		SHB140 PICMG 1.3 (full-size) PCIe SBC	
Processor Type	7 th /8 th /9 th Gen Intel® Core™ i7, i5, i3 series or Intel® Xeon® E-21XX series		Xeon® W-21XX series		6 th / 7 th Gen Intel® Core™ i7, i5, i3 series	
Chipset	Intel® C246 Express		Intel® C422 Workstation		Intel® Q170	
Memory	4x DDR4 2666 non-ECC Max. 64 GB (2x 4 GB, 2x 8 GB, 2x 16 GB, 4 x 16 GB)		8x DDR4 2666 ECC Max. 512 GB (2x 8 GB, 2x 16 GB, 2x 32 GB)		2x DDR4 2400 UDIMM non-ECC Max. 32 GB (2x 4 GB, 2x 8 GB, 2x 16 GB)	
Graphics	Intel UHD 630 on-board				Intel UHD 630 on-board	
Front I/O						
USB	2x USB 2.0		2x USB 2.0		2x USB 2.0	
Drive bays						
Front Accessible	3x 5.25" drive bays	SATA drive bay	3x 5.25" drive bay	SATA drive bay	3x 5.25" drive bays	SATA drive bay
Internal	1x 3.5" drive bay	SATA drive bay	1x 3.5" drive bay	SATA drive bay	1x 3.5" drive bay	SATA drive bay
Rear I/O						
USB	4x USB 2.0 2x USB 3.1 Gen1 2x USB 3.1 Gen2		6x USB 3.1 Gen1 Type A 1x USB 3.1 Gen2 Type A 1x USB 3.1 Gen 2 Type C		2x USB 3.0	
LAN	2x 1 Gb (1x i219LM & 1x i210AT) 10/100/1000 Mb/s iAMT /vPro & Teaming		2x 1 Gb (1x i219LM & 1x i210L) 10/100/1000 Mb/s iAMT/vPro & Teaming		2x 1 Gb 1x i219LM 10/100/ 1000 Mb/s & iATM/vPro,	1x i211AT 10/100/ 1000 Mb/s
Display	1x DVI-D (1920 x 1200 @60 Hz) 2x DP V1.2 (4096x2304 @60Hz)		No on-board Graphics (Add PCIe graphics card)		1x DVI-I	
PS/2	Keyboard, Mouse		Keyboard, Mouse			
Audio	1x Line in, 1x Line out 1x Microphone		1x Line in, 1x Line out 1x Microphone		(Available via internal header)	
Serial Port	1x RS232		1x RS232		1x RS232/422/485	
(Two optional additional serial ports cutouts on the rear side of the chassis)						
Expansion Slots						
Expansion Slots	5x PCIe (full height, full length) 2x PCI (full height, full length)		7x PCIe (full height, full length)		4x PCI (full height, full length) 3x PCI (full height, half length) 2x PCIe 2.0 (full height, full length) 3x PCIe 2.0 (full height, half length)	
Mass Storage Device (options)						
Mass Storage	1x M.2 2280 (PCIe 4 lanes)		1x M.2 2280 (PCIe 4 lanes)			

	KISS 4U V3 CFL	KISS 4U V3 SKW	KISS 4U V3 PCI763
Fans			
System Fan (External)	2x fans included in removable fan assembly	2x fans included in removable fan assembly	2x fans included in removable fan assembly
Internal fans	1xPSU (integrated in PSU) 1xCPU (heatsink with fan)	1xPSU (integrated in PSU) 1xCPU (heatsink with fan)	1x PSU (integrated in PSU) 1xCPU (heatsink with fan)
Software			
OS	<ul style="list-style-type: none"> ▶ MS Windows 10 IoT x64 ▶ Linux 	MS Windows 10 IoT x64	MS Windows 10 IoT x64
BIOS	UEFI BIOS ^[1]	UEFI BIOS ^[1]	

^[1] Support for UEFI only.



UEFI only! No legacy support and no Master Boot Record (MBR) installation.

11.3. Power Specification

	KISS 4U V3 CFL	KISS 4U V3 SKW	KISS 4U V3 PCI763
Single PSU			
Type	Industrial AC/DC	Industrial AC/DC	Industrial AC/DC
Output Power	600 W	600 W	600 W
Input Voltage Range	240 VAC to 100 VAC ^[1] (50 Hz to 60 Hz)	240 VAC to 100 VAC ^[1] (50 Hz to 60 Hz)	240 VAC to 100 VAC ^[1] (50 Hz to 60 Hz)
Input Current	8 A Max.	8 A Max.	8 A Max.
Redundant PSU (option)			
Type	Redundant Industrial AD/DC ^[2]	Redundant Industrial AD/DC ^[2]	
Output Power	500 W	500 W	
Input Voltage Range	240 VAC to 100 VAC ^[1] (50 Hz to 60 Hz)	240 VAC to 100 VAC ^[1] (50 Hz to 60 Hz)	
Input Current	8 A Max.	8 A Max.	

^[1] The electrical specification is available on the type label. For more information, see Chapter 3.3: Type Label.

^[2] The redundant PSU is only available for the KISS 4U V3 CFL and KISS 4U V3 SKW.

11.4. Mechanical Specification

Dimension	KISS 4U V3 (with front panel & handles)	KISS 4U V3 (without front panel & handles)
Height (4U)	177 mm (6.97")	177 mm (6.97")
Width	482 mm (19")	430 mm (16.93")
Depth	490 mm (19.29")	472 mm (18.58")
Weight	15 kg (approx.)	
Chassis	Chassis: RAL 7021 Front panel: RAL 9022 - standard Front panel: RAL 5017 - option	



For detailed mechanical dimensions, visit Kontron's EMD Customer Section:
<https://www.kontron.com/support-and-services/support/customer-section>.

11.5. Environmental Specification

Temperature		Description
Temperature	Operating	0 °C to +50 °C (+50°F to +122 °F)
	Storage & Transit	-20°C to +70°C (-4°F to +158°F)
Relative Humidity	Operating and Storage & Transit	10-93 % @ 40° C, non-condensing
Environment		Description
Altitude	Operating	5,000 m (16,400 ft.) Max.
	Storage & Transit	10,000 m (32,810 ft.) Max.
Shock	Operating	15 g, 11 ms, duration
	Storage & Transit	30 g, 11 ms, duration
Vibration	Operating	10 – 150 Hz, 1.0 g, 3 axis
	Storage & Transit	10 – 150 Hz, 2.0 g, 3 axis
MTBF		50,000h @ 30°C (min. configuration)

11.6. Compliance

The KISS 4U V3 complies with the European Council Directive and the approximation of the laws of the member states. If modified, the prerequisites for specific approvals may no longer apply.

Kontron is not responsible for any radio television interference caused by unauthorized modifications of the product or the substitution or attachment of connecting cables and equipment other than those specified by Kontron. The correction of interference caused by such unauthorized modification, substitution or attachment will be the responsibility of the user.

CE		
CE Marking	Council Directive	93/68/EEC
Safety	General Product Safety Directive (GPSD)	2001/95/EC
	Low Voltage Directive (LVD)	2014/35/EU
Electromagnetic Compatibility	Electromagnetic Compatibility Directive (EMC)	2014/30/EU
EMC		
Emission (Class B)	EN 55032	Electromagnetic compatibility of multimedia equipment- Emission requirements
	EN 61000-6-3	Emission standard for residential, commercial and light-industrial environments
Immunity (Industrial Equipment)	EN 55024	Information technology equipment- Immunity characteristics
	EN61000-6-2	Immunity for industrial environments
Safety		
Europe	EN 62368-1	Audio/video, information and communication technology equipment – Safety requirements
CB Scheme	CB report - IEC 62368-1	
Environment		
WEEE	Compliant with the Waste Electrical and Electronic Equipment (WEEE) 2012/19/EU directive; to reduce waste of electrical and electronic equipment, encourage recycling and environmental disposal and increase the environmental awareness of producers	
RoHS II	Compliant with the Restriction of Hazardous Substances (RoHS) 2011/65/EU directive or the late status thereof, to reduce hazardous substances in electrical and electronic equipment	
REACH	Compliant with the Registration, Evaluation, Authorization and Restriction of Chemicals (REACH) Regulation No. 1907/2006 to identify the intrinsic properties of chemical substances earlier.	

12/ Standard Interfaces- Pin Assignments

12.1. Keyboard Connector Pin Assignment

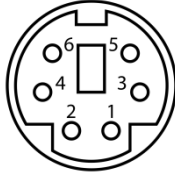
Pin	Signal Name	Keyboard Connector
1	Data	
2	NC	
3	GND	
4	+5V ^[1]	
5	Clock	
6	Keyboard_On ^[2]	

^[1] fuse protected

^[2] low asserted pulse

12.2. PS/2 Mouse Connector Pin Assignment

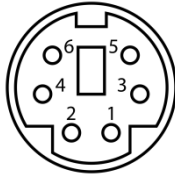
Pin	Signal Name	PS/2 Connector
1	Data	
2	NC	
3	GND	
4	+5V ^[1]	
5	Clock	
6	Keyboard_On ^[2]	

^[1] fuse protected

^[2] low asserted pulse

12.3. USB 2.0 Port Pin Assignment

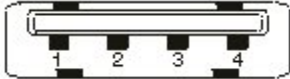
Pin	Signal Name	USB 2.0 Type A Connector
1	+5V ^[1]	
2	Data-	
3	Data+	
4	GND	

^[1] fuse protected

12.4. Display Port Pin Assignment

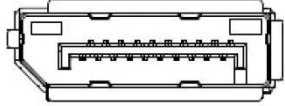
Pin	Signal Name	Pin	Signal Name	DP (V1.2) Connector
1	TX0+	11	GND	
2	GND	12	TX3-	
3	TX0-	13	DVI dongle detect/ GND	
4	TX1+	14	GND / CEC for HDMI	
5	GND	15	AUX+	
6	TX1-	16	GND	
7	TX2+	17	AUX-	
8	GND	18	Hotplug detect	
9	TX2-	19	GND	
10	TX3+	20	+3.3 V ^[1]	

^[1] (fuse protected)

12.5. COM 1 Connector Pin Assignment

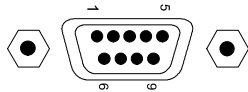
Pin	RS232	RS422	RS 485 Half Duplex	RS 485 Full Duplex	COM Connector
1	DCD	Tx-	Data-	Tx-	
2	RxD	Tx+	Data+	Tx+	
3	TxD	Rx+		Rx+	
4	DTR	Rx-		Rx-	
5	GND	GND	GND	GND	
6	DSR				
7	RTS				
8	CTS				
9	RI				

12.6. DVI-D Connector Pin Assignment

The DVI-D Dual-link connector supports single-link only.

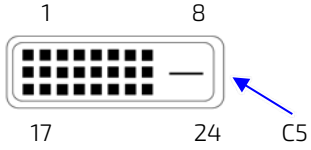
Pin	Signal Name	Pin	Signal Name	Pin	Signal Name	DVI-D Connector	
1	Data2-	9	Data1-	17	Data0-		
2	Data2+	10	Data1+	18	Data0+		
3	GND	11	GND	19	GND		
4	NC	12	NC	20	NC		
5	NC	13	NC	21	NC		
6	DDC Clock	14	+5 V ^[1]	22	GND		
7	DDC Data	15	GND	23	Clk +		
8	NC	16	Hot Plug Detect	24	Clk -		
						C5	GND

^[1] fuse protected

12.7. DVI-I Connector Pin Assignment

Pin	Signal Name	Pin	Signal Name	Pin	Signal Name	DVI-D Connector	
1	Data2-	9	Data1-	17	Data0-		
2	Data2+	10	Data1+	18	Data0+		
3	GND	11	GND	19	GND		
4	NC	12	NC	20	NC		
5	NC	13	NC	21	NC		
6	DDC Clock	14	+5 V	22	GND		
7	DDC Data	15	GND	23	Clk +		
8	NC	16	Hot Plug Detect	24	Clk -		
						C1	Analog red
						C2	Analog green
						C3	Analog blue
						C4	Analog horizontal sync.
						C5	GND

12.8. LAN Connector Pin Assignment

Pin	Signal (10/100/1000 Mb/s)	Pin	Signal (10/100 Mb/s)	RJ45 (female) Connector
1	MX1+	1	TX+	
2	MX1-	2	TX-	
3	MX2+	3	RX+	
4	MX3+	4	NC	
5	MX3-	5	NC	
6	MX2-	6	RX-	
7	MX4+	7	NC	
8	MX4-	8	NC	

12.9. USB 3.0 and USB 3.1 (Gen1/Gen2) Port Pin Assignment

Pin	Signal Name	Pin	Signal Name	USB 3.0/3.1[2] Type A Connector
1	+5V ^[1]	5	USB3_RX-	
2	USB2_D-	6	USB3_RX+	
3	USB2_D+	7	GND	
4	GND	8	USB3_TX-	
		9	USB3_TX+	

^[1] fuse protected



^[2] All USB 3.1 connectors provide separate signal lines for USB 3.1 and USB 2.0.

12.10. USB 3.1 (Gen 2) Type C Port Pin Assignment

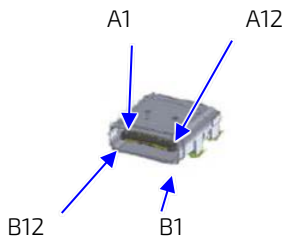
Pin	Signal Name	Pin	Signal Name
A1	GND	B1	GND
A2	USB2_TX1+	B"	USB2_TX2+
A3	USB2_TX1-	B3	USB2_TX2-
A4	VCC AUX	B4	VCC AUX
A5	Config. Channel 1	B5	Config. Channel 2
A6	USB2 Data+	B6	USB2 Data+
A7	USB2 Data-	B7	USB2 Data-
A8	Sideband1	B8	Sideband2
A9	VCC AUX	B9	VCC AUX
A10	USB3_RX2-	B10	USB3_RX1-
11	USB3_RX2+	B11	USB3_RX1+
12	GND	B12	GND



12.11. Audio Jack Pin Assignment

Jack	Signal	Audio Barrel Jack
A	Line-in	
B	Line-out	
C	Microphone-in	

13/ Technical Support

In order to request technical support, send an email with the information below to support@kontron.com

- ▶ Product name
- ▶ Product model number
- ▶ Serial number of the unit
- ▶ Brief problem description
- ▶ Complete company address

Customers with service portal access may maintain their tickets directly in the service portal.



The serial number can be found on the product's type label.

13.1. Returning Defective Merchandise

All equipment returned to Kontron must have a Return of Material Authorization (RMA) number assigned exclusively by Kontron. Kontron cannot be held responsible for any loss or damage caused to the equipment received without an RMA number. The buyer accepts responsibility for all freight charges for the return of goods to Kontron's designated facility. Kontron will pay the return freight charges back to the buyer's location in the event that the equipment is repaired or replaced within the stipulated warranty period.

Follow these steps before returning any product to Kontron.

1. Visit the RMA Information website:



Kontron's RMA Information website can be found at:

<http://www.kontron.com/support-and-services/support/rma-information>

2. Download the RMA Request sheet for Kontron Europe GmbH, Augsburg and fill out the form. Take care to include a short detailed description of the observed problem or failure and to include the product identification (product name, material number and serial-number). If more than one product is sent in a delivery. Fill out the above information in the RMA Request form for each product.
3. Send the completed RMA-sheet to the given fax or email address at Kontron Europe GmbH. Kontron Europe GmbH will provide an RMA-Number within one business day.
4. The goods for repair shall be packed properly for shipping, considering shock and ESD protection.



Goods returned to Kontron Europe GmbH in non-proper packaging are considered as customer caused faults and cannot be accepted as warranty repairs.

5. Add the RMA-sheet to the relevant delivery address and include the RMA-No with the shipping paperwork.

Sent the product to the following delivery address:

Kontron Europe GmbH
RMA Support
Lise-Meitner-Str. 3-5
86156 Augsburg
Germany

Phone: +49 (0) 821 4086-0
Fax: +49 (0) 821 4086 111
Email: service@kontron.com

6. After receiving the product, Kontron Europe GmbH sends a confirmation of the order to the email address named on the RMA sheet.

14/ Storage and Transportation

14.1. Storage

If the product is not in use for an extended period time, disconnect the power plug from the mains power source. If it is necessary to store the product, then re-pack the product as originally delivered to avoid damage. The storage facility must meet the products environmental storage requirements as stated within this user guide. Kontron recommends keeping the original packaging material for future storage or warranty shipments.

14.2. Transportation

To ship the product, use the original packaging, designed to withstand impact and adequately protect the product. When packing or unpacking products always take shock and ESD protection into consideration and use an EOS/ESD safe working area.

15/ Warranty

Kontron defines product warranty in accordance with regional warranty definitions. Claims are at Kontron's discretion and limited to the defect being of a material nature. To find out more about the warranty conditions and the defined warranty period for your region, following the steps below:

1. Visit Kontron's Term and Conditions webpage.
<http://www.kontron.com/terms-and-conditions>
2. Click on your region's General Terms and Conditions of Sale.

15.1. Limitation/Exemption from Warranty Obligation

In general, Kontron shall not be required to honor the warranty, even during the warranty period, and shall be exempted from the statutory accident liability obligations in the event of damage caused to the product due to failure to observe the following:

- ▶ General safety instructions for IT equipment within this user guide
- ▶ Warning labels on the product and warning symbols within this user guide
- ▶ Information and hints within this user guide

Additionally, alterations or modifications to the product that are not explicitly approved by Kontron, described in this user guide, or received from Kontron Support as a special handling instruction will void your warranty.

Due to their limited service life, parts that by their nature are subject to a particularly high degree of wear (wearing parts) are excluded from the warranty beyond that provided by law.

List of Acronyms

Table 7: List of Acronyms

AMT	Active Management Technology
ATX	Advanced Technology eXtended
BIOS	Basic Input Output System
CLI	Command-Line Interface
COM	Communication port
CPU	Central Processing Unit
DC	Direct Current
DDR	Double Data Rate
DIMM	Dual Inline Memory Module
DP	Display port
DVD	Digital Video Device
DVI	Digital Video Interface
ECC	Error Checking and Correction
EMC	Electromagnetic Compatibility
ESD	ElectroStatic Discharge
GbE	Giga bit Ethernet
GPSD	General Product Safety Directive
GPU	Graphics Processing Unit
HD/HDD	Hard Disk /Drive
HPM	PICMG Hardware Platform Management specification family
iAMT	Intel® Active Management Technology
IOL	IPMI-Over-LAN
IOT	Internet of Things
IPMI	Intelligent Platform Management Interface
KCS	Keyboard Controller Style
KBD	Keyboard
KVM	Keyboard Video Mouse
LAN	Local Area Network
LED	Light-Emitting Diode
LVD	Low Voltage Directive
MEI	Management Engine Interface
NCSI	Network Communications Services Interface
OS	Operating System
PCB	Plastic Circuit Board
PCI	Peripheral Component Interconnect
PCIe	PCI-Express
PECI	Platform Environment Control Interface

PICMG®	PCI Industrial Computer Manufacturers Group
PSU	Power Supply Unit
PXE	Preboot Execution Environment
RAM	Random Access memory
RDIMM	Registered DIMM
REACH	Registration, Evaluation, Authorization and restriction of Chemicals
RMA	Return of Material Authorization
RTC	Real Time Clock
SBC	Single Board Computer
SEL	System Event Log
ShMC	Shelf Management Controller
SMBus	System Management Bus
SMWI	System Monitor Web Interface
SOL	Serial Over LAN
SRAM	Synchronous Dynamic Random Access Memory
SSD	Solid State Drive
SSH	Secure Shell
TPM	Trusted Platform Module
UDIMM	Unregisterd DIMM
UEFI	Unified Extensible Firmware Interface
USB	Universal Serial Bus
WEEE	Waste Electrical and Electronic Equipment
WoL	Wake on LAN



About Kontron

Kontron is a global leader in IoT/Embedded Computing Technology (ECT). Kontron offers individual solutions in the areas of Internet of Things (IoT) and Industry 4.0 through a combined portfolio of hardware, software and services. With its standard and customized products based on highly reliable state-of-the-art technologies, Kontron provides secure and innovative applications for a wide variety of industries. As a result, customers benefit from accelerated time-to-market, lower total cost of ownership, extended product lifecycles and the best fully integrated applications.

For more information, please visit: www.kontron.com



Global Headquarters

Kontron Europe GmbH

Gutenbergstraße 2
85737 Ismaning
Germany
www.kontron.com