



# KBox A-150-BYT

Doc. User Guide Rev. 1.4

Doc. ID: 1062-3586

This page has been intentionally left blank

 KBOX A-150-BYT - USER GUIDE

## Disclaimer

Kontron would like to point out that the information contained in this user guide may be subject to alteration, particularly as a result of the constant upgrading of Kontron products. This document does not entail any guarantee on the part of Kontron with respect to technical processes described in the user guide or any product characteristics set out in the user guide. Kontron assumes no responsibility or liability for the use of the described product(s), conveys no license or title under any patent, copyright or mask work rights to these products and makes no representations or warranties that these products are free from patent, copyright or mask work right infringement unless otherwise specified. Applications that are described in this user guide are for illustration purposes only. Kontron makes no representation or warranty that such application will be suitable for the specified use without further testing or modification. Kontron expressly informs the user that this user guide only contains a general description of processes and instructions which may not be applicable in every individual case. In cases of doubt, please contact Kontron.

This user guide is protected by copyright. All rights are reserved by Kontron. No part of this document may be reproduced, transmitted, transcribed, stored in a retrieval system, or translated into any language or computer language, in any form or by any means (electronic, mechanical, photocopying, recording, or otherwise), without the express written permission of Kontron. Kontron points out that the information contained in this user guide is constantly being updated in line with the technical alterations and improvements made by Kontron to the products and thus this user guide only reflects the technical status of the products by Kontron at the time of publishing.

Brand and product names are trademarks or registered trademarks of their respective owners.

©2018 by Kontron Europe GmbH

Kontron Europe GmbH

Gutenbergstraße 2  
85737 Ismaning  
Germany  
[www.kontron.com](http://www.kontron.com)

## Intended Use

THIS DEVICE AND ASSOCIATED SOFTWARE ARE NOT DESIGNED, MANUFACTURED OR INTENDED FOR USE OR RESALE FOR THE OPERATION OF NUCLEAR FACILITIES, THE NAVIGATION, CONTROL OR COMMUNICATION SYSTEMS FOR AIRCRAFT OR OTHER TRANSPORTATION, AIR TRAFFIC CONTROL, LIFE SUPPORT OR LIFE SUSTAINING APPLICATIONS, WEAPONS SYSTEMS, OR ANY OTHER APPLICATION IN A HAZARDOUS ENVIRONMENT, OR REQUIRING FAIL-SAFE PERFORMANCE, OR IN WHICH THE FAILURE OF PRODUCTS COULD LEAD DIRECTLY TO DEATH, PERSONAL INJURY, OR SEVERE PHYSICAL OR ENVIRONMENTAL DAMAGE (COLLECTIVELY, "HIGH RISK APPLICATIONS").

You understand and agree that your use of Kontron devices as a component in High Risk Applications is entirely at your risk. To minimize the risks associated with your products and applications, you should provide adequate design and operating safeguards. You are solely responsible for compliance with all legal, regulatory, safety, and security related requirements concerning your products. You are responsible to ensure that your systems (and any Kontron hardware or software components incorporated in your systems) meet all applicable requirements. Unless otherwise stated in the product documentation, the Kontron device is not provided with error-tolerance capabilities and cannot therefore be deemed as being engineered, manufactured or setup to be compliant for implementation or for resale as device in High Risk Applications. All application and safety related information in this document (including application descriptions, suggested safety measures, suggested Kontron products, and other materials) is provided for reference only.

---

**NOTICE**

You find the most recent version of the "General Safety Instructions" online in the download area of this product.

---

## Revision History

Revision	Brief Description of Changes	Date of Issue	Author/Editor
1.0	Initial version	2018-Oct-02	CW
1.1	Ethernet LED functionality corrected, scope of delivery and accessories updated, added an extra battery warning and updates Figure 26, pos. 3.	2019-Dec-17	CW
1.2	Updated general safety instructions, added additional PSU spec. data and LPS PSU caution and wiring restriction info	2020-Sept-10	CW
1.3	Renamed Chapter 3 Compliance. Updated boiler text, company name and address, General Safety Instructions and RMA link. Changed Battery warning in Ch. 1.2 and Ch.15.3.2. Disposal Chapter removed	2022-Jan-05	CW
1.4	Replace Ubuntu with Linux and added new logo	2023-Sept-06	CW

## Terms and Conditions

Kontron warrants products in accordance with defined regional warranty periods. For more information about warranty compliance and conformity, and the warranty period in your region, visit <http://www.kontron.com/terms-and-conditions>.

Kontron sells products worldwide and declares regional General Terms & Conditions of Sale, and Purchase Order Terms & Conditions. Visit <http://www.kontron.com/terms-and-conditions>.

For contact information, refer to the corporate offices contact information on the last page of this user guide or visit our website [CONTACT US](#).

## Customer Support

Find Kontron contacts by visiting: <https://www.kontron.com/en/support>.

## Customer Service

As a trusted technology innovator and global solutions provider, Kontron extends its embedded market strengths into a services portfolio allowing companies to break the barriers of traditional product lifecycles. Proven product expertise coupled with collaborative and highly-experienced support enables Kontron to provide exceptional peace of mind to build and maintain successful products.

For more details on Kontron's service offerings such as: enhanced repair services, extended warranty, Kontron training academy, and more visit <https://www.kontron.com/en/service>

## Customer Comments

If you have any difficulties using this user guide, discover an error, or just want to provide some feedback, contact [Kontron Support](#). Detail any errors you find. We will correct the errors or problems as soon as possible and post the revised user guide on our website.

## Symbols

The following symbols may be used in this user guide

### **⚠ DANGER**

DANGER indicates a hazardous situation which, if not avoided, will result in death or serious injury.

### **⚠ WARNING**

WARNING indicates a hazardous situation which, if not avoided, could result in death or serious injury.

### **NOTICE**

NOTICE indicates a property damage message.

### **⚠ CAUTION**

CAUTION indicates a hazardous situation which, if not avoided, may result in minor or moderate injury.



Electric Shock!

This symbol and title warn of hazards due to electrical shocks (> 60 V) when touching products or parts of products. Failure to observe the precautions indicated and/or prescribed by the law may endanger your life/health and/or result in damage to your material.



ESD Sensitive Device!

This symbol and title inform that the electronic boards and their components are sensitive to static electricity. Care must therefore be taken during all handling operations and inspections of this product in order to ensure product integrity at all times.



HOT Surface!

Do NOT touch! Allow to cool before servicing.



Laser!

This symbol informs of the risk of exposure to laser beam and light emitting devices (LEDs) from an electrical device. Eye protection per manufacturer notice shall review before servicing.



This symbol indicates general information about the product and the user guide.

This symbol also indicates detail information about the specific product configuration.



This symbol precedes helpful hints and tips for daily use.

## For Your Safety

Your new Kontron product was developed and tested carefully to provide all features necessary to ensure its compliance with electrical safety requirements. It was also designed for a long fault-free life. However, the life expectancy of your product can be drastically reduced by improper treatment during unpacking and installation. Therefore, in the interest of your own safety and of the correct operation of your new Kontron product, you are requested to conform with the following guidelines.

### High Voltage Safety Instructions

As a precaution and in case of danger, the power connector must be easily accessible. The power connector is the product's main disconnect device.

#### **⚠ CAUTION**

##### Warning

All operations on this product must be carried out by sufficiently skilled personnel only.

#### **⚠ CAUTION**



##### Electric Shock!

Before installing a non hot-swappable Kontron product into a system always ensure that your mains power is switched off. This also applies to the installation of piggybacks. Serious electrical shock hazards can exist during all installation, repair, and maintenance operations on this product. Therefore, always unplug the power cable and any other cables which provide external voltages before performing any work on this product.

Earth ground connection to vehicle's chassis or a central grounding point shall remain connected. The earth ground cable shall be the last cable to be disconnected or the first cable to be connected when performing installation or removal procedures on this product.

### Special Handling and Unpacking Instruction

#### **NOTICE**



##### ESD Sensitive Device!

Electronic boards and their components are sensitive to static electricity. Therefore, care must be taken during all handling operations and inspections of this product, in order to ensure product integrity at all times.

Do not handle this product out of its protective enclosure while it is not used for operational purposes unless it is otherwise protected.

Whenever possible, unpack or pack this product only at EOS/ESD safe work stations. Where a safe work station is not guaranteed, it is important for the user to be electrically discharged before touching the product with his/her hands or tools. This is most easily done by touching a metal part of your system housing.

It is particularly important to observe standard anti-static precautions when changing piggybacks, ROM devices, jumper settings etc. If the product contains batteries for RTC or memory backup, ensure that the product is not placed on conductive surfaces, including anti-static plastics or sponges. They can cause short circuits and damage the batteries or conductive circuits on the product.

## Lithium Battery Precautions

If your product is equipped with a lithium battery, take the following precautions when replacing the battery.

### **CAUTION**

---

**Danger of explosion if the battery is replaced incorrectly.**

- ▶ Replace only with same or equivalent battery type recommended by the manufacturer.
  - ▶ Dispose of used batteries according to the manufacturer's instructions.
- 

## General Instructions on Usage

In order to maintain Kontron's product warranty, this product must not be altered or modified in any way. Changes or modifications to the product, that are not explicitly approved by Kontron and described in this user guide or received from Kontron Support as a special handling instruction, will void your warranty.

This product should only be installed in or connected to systems that fulfill all necessary technical and specific environmental requirements. This also applies to the operational temperature range of the specific board version that must not be exceeded. If batteries are present, their temperature restrictions must be taken into account.

In performing all necessary installation and application operations, only follow the instructions supplied by the present user guide.

Keep all the original packaging material for future storage or warranty shipments. If it is necessary to store or ship the product, then re-pack it in the same manner as it was delivered.

Special care is necessary when handling or unpacking the product. See Special Handling and Unpacking Instruction.

## Quality and Environmental Management

Kontron aims to deliver reliable high-end products designed and built for quality, and aims to complying with environmental laws, regulations, and other environmentally oriented requirements. For more information regarding Kontron's quality and environmental responsibilities, visit <http://www.kontron.com/about-kontron/corporate-responsibility/quality-management>.

## Disposal and Recycling

Kontron's products are manufactured to satisfy environmental protection requirements where possible. Many of the components used are capable of being recycled. Final disposal of this product after its service life must be accomplished in accordance with applicable country, state, or local laws or regulations.

## WEEE Compliance

The Waste Electrical and Electronic Equipment (WEEE) Directive aims to:

- ▶ Reduce waste arising from electrical and electronic equipment (EEE)
- ▶ Make producers of EEE responsible for the environmental impact of their products, especially when the product become waste
- ▶ Encourage separate collection and subsequent treatment, reuse, recovery, recycling and sound environmental disposal of EEE
- ▶ Improve the environmental performance of all those involved during the lifecycle of EEE



---

**Environmental protection is a high priority with Kontron.**  
Kontron follows the WEEE directive

---



# Table of Contents

<b>Symbols</b> .....	<b>6</b>
<b>For Your Safety</b> .....	<b>7</b>
High Voltage Safety Instructions .....	7
Special Handling and Unpacking Instruction .....	7
Lithium Battery Precautions.....	8
<b>General Instructions on Usage</b> .....	<b>8</b>
<b>Quality and Environmental Management</b> .....	<b>8</b>
Disposal and Recycling.....	8
WEEE Compliance.....	8
<b>Table of Contents</b> .....	<b>9</b>
<b>List of Tables</b> .....	<b>11</b>
<b>List of Figures</b> .....	<b>11</b>
<b>1/ General Safety Instructions</b> .....	<b>13</b>
1.1. Electrostatic Discharge (ESD).....	14
1.1.1. Grounding Methods .....	14
1.2. Instructions for Lithium Battery.....	15
<b>2/ Introduction</b> .....	<b>16</b>
<b>3/ Compliance</b> .....	<b>17</b>
<b>4/ Shipment and Unpacking</b> .....	<b>19</b>
4.1. Packaging.....	19
4.2. Unpacking .....	19
4.3. Scope of Delivery.....	19
4.4. Accessories .....	19
4.5. Optional Parts.....	19
4.6. Optional System Expansion.....	19
4.7. Kontron Optional mPCIe Modules.....	20
4.8. Type Label and Product Identification .....	20
<b>5/ Product Overview</b> .....	<b>21</b>
5.1. Front Panel Views .....	22
5.1.1. Input Power Connector.....	23
5.1.2. Protective Earth Stud Bolt .....	23
5.1.3. VGA.....	23
5.1.4. HDMI (HDMI).....	23
5.1.5. Ethernet (LAN1, LAN2) .....	23
5.1.6. USB 3.0 .....	23
5.1.7. USB 2.0.....	23
5.1.8. Power-On .....	23
5.1.9. Serial Ports (X1, X2) and (option X3, X4).....	23
5.2. Rear View.....	24
5.3. Top and Bottom View.....	24
5.4. Side Views.....	25
<b>6/ System Extension</b> .....	<b>26</b>
6.1. Storage .....	26
6.1.1. External HDD/SSD Drive Bay .....	26
6.1.2. Internal mSATA SSD.....	26
6.2. Expansion Cards - mPCIe.....	26
<b>7/ Accessing Components</b> .....	<b>27</b>

7.1. Accessing External Components.....	27
7.1.1. HDD/SSD Drive Bay.....	27
7.2. Accessing Internal Components.....	28
7.2.1. Opening the Chassis.....	28
7.2.2. Installing and Removing Internal mSATA SSD.....	29
7.2.3. Installing and Removing mPCIe Expansion Cards.....	30
<b>8/ Thermal Considerations.....</b>	<b>31</b>
8.1. Heatsink.....	31
8.2. Heatsink (Optional).....	31
<b>9/ Installation Instructions.....</b>	<b>32</b>
9.1. DIN Rail Mounting.....	32
9.2. Wiring the Mating Power Connector/Terminal.....	33
<b>10/ Starting Up.....</b>	<b>34</b>
10.1. Connecting to an External DC Power Supply.....	34
10.1.1. Switch On.....	35
10.2. Operating System (OS) and Drivers.....	35
<b>11/ Technical Data.....</b>	<b>36</b>
11.1. Block Diagram.....	36
11.2. Technical Specification.....	37
11.3. Mechanical Specification.....	37
11.4. Environmental Specification.....	40
11.5. Power Specification.....	41
11.5.1. Power Supply Protection Requirements.....	41
11.5.2. Power Consumption.....	42
11.5.3. Protective Earth Stud Bolt.....	42
<b>12/ Connector, Socket and Jumper Pin Assignments.....</b>	<b>43</b>
12.1. Front Panel Connectors.....	43
12.2. Front Panel Connector Pin Assignments.....	43
12.2.1. Input Power Connector.....	43
12.2.2. VGA DB15 Connector.....	44
12.2.3. HDMI Connector (HDMI).....	44
12.2.4. GbE LAN1 RJ45 Connectors (LAN1, LAN2).....	45
12.2.5. USB 3.0 Port Connector.....	45
12.2.6. USB 2.0 Type A Connector.....	45
12.2.7. Serial Port Connectors (X1, X2).....	45
12.3. Internal Connectors and Sockets.....	46
12.4. Internal Connector and Socket Pin Assignments.....	47
12.4.1. 12 V DC Out Power Connector.....	47
12.4.2. Battery Power Input Connector.....	47
12.4.3. HDD Power Output Connector.....	47
12.4.4. Front Panel 1-Pin Header.....	47
12.4.5. Front Panel 2-Pin Header.....	47
12.4.6. Serial ATA Port 0 Connector.....	48
12.4.7. mPCIe Express V 1.2 Socket –Full Size.....	48
12.4.8. mSATA Socket Serial ATA port 1- Full Size.....	49
12.5. Jumpers.....	50
12.6. Jumper Pin Assignments.....	50
12.6.1. RTC Reset Selection (JP1) Pitch 2.54 mm.....	50
12.6.2. RTC Battery Test (JP3) Pitch 2.54 mm.....	50

12.6.3. USB Power Selection (JP6) Pitch 2.00 mm.....	51
12.6.4. AT/ATX Power Mode Selection (JP7) Pitch 2.54 mm.....	51
<b>13/ BIOS.....</b>	<b>52</b>
13.1. Starting the uEFI BIOS .....	52
13.2. Setup Menus.....	53
13.2.1. Main Setup Menu .....	53
13.2.2. Advanced Setup Menu .....	54
13.2.3. Boot Setup Menu .....	58
13.2.4. Security Setup Menu .....	59
13.2.5. Save and Exit Setup Menu .....	60
<b>14/ Technical Support.....</b>	<b>61</b>
14.1. Returning Defective Merchandise .....	61
<b>15/ Storage, Transportation and Maintenance .....</b>	<b>61</b>
15.1. Storage.....	62
15.2. Transportation.....	62
15.3. Maintenance.....	62
15.3.1. Cleaning.....	62
15.3.2. Replacing the Lithium Battery.....	62
<b>16/ Warranty.....</b>	<b>63</b>
16.1. Limitation/Exemption from Warranty Obligation.....	63
<b>17/ Disposal.....</b>	<b>Error! Bookmark not defined.</b>
<b>Appendix: List of Acronyms .....</b>	<b>64</b>
About Kontron .....	65

## List of Tables

Table 1: Standards, Certifications and Directives Compliance .....	17
Table 2: Scope of Delivery .....	19
Table 3: Accessories .....	19
Table 4: Technical Specification .....	37
Table 5: Software Specification .....	37
Table 6: Mechanical Specification .....	37
Table 7: Environmental Specification .....	40
Table 8: KBox A-BYT Electrical Specification .....	41
Table 9: Power Consumption .....	42
Table 10: Front Panel Connectors .....	43
Table 11: Internal Connectors Top side.....	46
Table 12: Jumpers .....	50
Table 13: Navigation Hot Keys Available in the Legend Bar .....	52
Table 14: Advanced Menu.....	54
Table 15: Boot Setup Menu Sub-screens and Functions .....	58
Table 16: Security Setup Menu Sub-screens and Functions.....	59
Table 17: Save and Exit Setup Menu Sub-screens and Functions .....	60
Table 18: List of Acronyms .....	64

## List of Figures

Figure 1: KBox A-150-BYT .....	16
Figure 2: KBox A-150-BYT Type Label.....	20
Figure 3: KBox A-150-BYT Chassis Variants .....	21
Figure 4: Front Panel View (External HDD/SSD drive bay).....	22
Figure 5: Front Panel (No External HDD/SSD drive bay) .....	22

Figure 6: Rear View .....	24
Figure 7: Top and bottom View .....	24
Figure 8: Side View .....	25
Figure 9: Side Views with 2.5" HDD/SSD Drive Bay .....	25
Figure 10: Mainboard Fastening Screws .....	28
Figure 11: Front Panel Fastening Screws .....	28
Figure 12: Heatsink and heatsink with DIN Rail Clamp .....	31
Figure 13: DIN Rail Retaining Clamp Upper Position.....	32
Figure 14: DIN Rail Mounting Clamp Screw Dimensions (Measurements in mm).....	32
Figure 15: Mating Power Connector/Terminal.....	33
Figure 16: Block Diagram.....	36
Figure 17: Front Panel Dimensions with HDD/SSD drive bay (Measurements in mm) .....	38
Figure 18: Rear Side Dimensions with HDD/SSD drive bay (Measurements in mm).....	38
Figure 19: Top Side Dimensions with HDD/SSD drive bay (Measurements in mm).....	38
Figure 20: Side View Dimensions with HDD/SSD drive bay (Measurements in mm).....	39
Figure 21: Front Panel Dimensions without drive bay (Measurements in mm).....	39
Figure 22: Rear Side Dimensions without drive bay (Measurements in mm).....	39
Figure 23: Top Side Dimensions without drive bay (Measurements in mm) .....	40
Figure 24: Side View Dimensions without drive bay (Measurements in mm).....	40
Figure 25: Front Panel Connectors .....	43
Figure 26: Internal Connectors Top View .....	46
Figure 27: Main Setup Menu Example .....	53
Figure 28: Advanced Setup Menu Example .....	54
Figure 29: Boot Setup Menu Example.....	58
Figure 30: Security Setup Menu Example.....	59
Figure 31: Save and Exit Set up Menu Example .....	60

## 1/ General Safety Instructions

Please read this passage carefully and take careful note of the instructions, which have been compiled for your safety and to ensure to apply in accordance with intended regulations. If the following general safety instructions are not observed, it could lead to injuries to the operator and/or damage of the product; in cases of non-observance of the instructions Kontron Europe is exempt from accident liability, this also applies during the warranty period.

The product has been built and tested according to the basic safety requirements for low voltage (LVD) applications and has left the manufacturer in safety-related, flawless condition. To maintain this condition and to also ensure safe operation, the operator must not only observe the correct operating conditions for the product but also the following general safety instructions:

- ▶ The product must be used as specified in the product documentation, in which the instructions for safety for the product and for the operator are described. These contain guidelines for setting up, installation and assembly, maintenance, transport or storage.
- ▶ The on-site electrical installation must meet the requirements of the country's specific local regulations.
- ▶ If a power cable comes with the product, only this cable should be used. Do not use an extension cable to connect the product.
- ▶ To guarantee that sufficient air circulation is available to cool the product, please ensure that the ventilation openings are not covered or blocked. If a filter mat is provided, this should be cleaned regularly. Do not place the product close to heat sources or damp places. Make sure the product is well ventilated.
- ▶ Only connect the product to an external power supply providing the voltage type (AC or DC) and the input power (max. current) specified on the Kontron Product Label and meeting the requirements of the Limited Power Source (LPS) and Power Source (PS2) of UL/IEC 62368-1.
- ▶ Only products or parts that meet the requirements for Power Source (PS1) of UL/IEC 62368-1 may be connected to the product's available interfaces (I/O).
- ▶ Before opening the product, make sure that the product is disconnected from the mains.
- ▶ Switching off the product by its power button does not disconnect it from the mains. Complete disconnection is only possible if the power cable is removed from the wall plug or from the product. Ensure that there is free and easy access to enable disconnection.
- ▶ The product may only be opened for the insertion or removal of add-on cards (depending on the configuration of the product). This may only be carried out by qualified operators.
- ▶ If extensions are being carried out, the following must be observed:
  - ▶ all effective legal regulations and all technical data are adhered to
  - ▶ the power consumption of any add-on card does not exceed the specified limitations
  - ▶ the current consumption of the product does not exceed the value stated on the product label.
- ▶ Only original accessories that have been approved by Kontron Europe can be used.
- ▶ Please note: safe operation is no longer possible when any of the following applies:
  - ▶ the product has visible damages or
  - ▶ the product is no longer functioning
 In this case the product must be switched off and it must be ensured that the product can no longer be operated.
- ▶ Handling and operation of the product is permitted only for trained personnel within a work place that is access controlled.
- ▶ CAUTION: Risk of explosion if the battery is replaced incorrectly (short-circuited, reverse-poled, wrong battery type). Dispose of used batteries according to the manufacturer's instructions.
- ▶ This product is not suitable for use in locations where children are likely to be present

### Additional Safety Instructions for DC Power Supply Circuits

- ▶ To guarantee safe operation, please observe that:
  - ▶ the external DC power supply must meet the criteria for LPS and PS2 (UL/IEC 62368-1)

- ▶ no cables or parts without insulation in electrical circuits with dangerous voltage or power should be touched directly or indirectly
  - ▶ a reliable protective earthing connection is provided
  - ▶ a suitable, easily accessible disconnecting device is used in the application (e.g. overcurrent protective device), if the product itself is not disconnectable
  - ▶ a disconnect device, if provided in or as part of the product, shall disconnect both poles simultaneously
  - ▶ interconnecting power circuits of different products cause no electrical hazards
- ▶ A sufficient dimensioning of the power cable wires must be selected – according to the maximum electrical specifications on the product label – as stipulated by EN62368-1 or VDE0100 or EN60204 or UL61010-1 regulations.

## 1.1. Electrostatic Discharge (ESD)



---

**A sudden discharge of electrostatic electricity can destroy static-sensitive devices or micro-circuitry.**

---

Therefore, proper packaging and grounding techniques are necessary precautions to prevent damage. Always take the following precautions:

1. Transport boards in ESD-safe containers such as boxes or bags.
2. Keep electrostatic sensitive parts in their containers until they arrive at the ESD-safe workplace.
3. Always be properly grounded when touching a sensitive board, component, or assembly.
4. Store electrostatic-sensitive boards in protective packaging or on antistatic mats.

### 1.1.1. Grounding Methods

By adhering to the guidelines below, electrostatic damage to the product can be avoided:

1. Cover workstations with approved antistatic material. Always wear a wrist strap connected to workplace. Always use properly grounded tools and equipment.
2. Use antistatic mats, heel straps, or air ionizers for more protection.
3. Always handle electrostatically sensitive components by their edge or by their casing.
4. Avoid contact with pins, leads, or circuitry.
5. Switch off power and input signals before inserting and removing connectors or connecting test equipment.
6. Keep work area free of non-conductive materials such as ordinary plastic assembly aids and Styrofoam.
7. Use only field service tools that are conductive, such as cutters, screwdrivers, and vacuum cleaners.
8. Always place drives and boards PCB-assembly-side down on the foam.

## 1.2. Instructions for Lithium Battery

The KBox A-150-BYT is equipped with a Kontron specific battery assembly and is not designed to operate without a battery. If the battery is empty or disconnected, the BIOS settings will be set to the factory defaults. To replace the battery, observe the instructions described in Chapter 15.3.2: Replacing the Lithium Battery.

---

**⚠ CAUTION**

Caution: Risk of Explosion if Battery is replaced by an Incorrect Type. Dispose of Used Batteries According to the Instructions.

ATTENTION: Risque d'explosion si la batterie est remplacée par un type incorrect. Mettre au rebus les batteries usagées selon les instructions.

---

After removing the lithium battery, dispose of the lithium battery according to the regulations within your region.



---

Do not dispose of lithium batteries in general trash collection. Dispose of the battery according to the local regulations dealing with the disposal of these special materials, (e.g. to collecting points for battery disposal).

---

## 2/ Introduction

This user guide describes the KBox A-150-BYT. New users are recommended to study the installation instructions within this user guide before switching on the power.

Kontron's KBox A-150-BYT is developed specifically for control cabinet applications with flexible DIN rail mounting positions for use when space is limited. The fanless design ensures a significantly prolonged lifespan and high system availability.

The KBox A-150-BYT is a high-end industrial grade box PC based on the Intel® Baytrail Celeron platforms designed for use in performance demanding applications. Due to the varied amount of onboard interfaces such as GbE, USB 3.0, USB 2.0, VGA and HDMI, the KBox A-150-BYT enables connectivity for nearly all applications and supports memory expandability via mSATA SSD memory expansion.

Key features are:

- ▶ Intel® Celeron Quad Core J1900
- ▶ Up to 8 GB RAM with DDR3L SODIMM
- ▶ 64 GB up to 512 GB memory storage via Internal SSD (option)
- ▶ External 2.5" HDD/SSD drive bay (option)
- ▶ External Interfaces 1x HDMI, 1x VGA, 2x GbE, 2x USB 2.0, 1x USB 3.0, 2x COM (RS232, RS422, RS485 configurable)
- ▶ Fanless passive cooling
- ▶ Supports Kontron's APPROTECT (option)

The KBox A-150-BYT is intended for 24/7 continuous operation and longtime industrial applications. All components are selected to ensure a long lifetime.

Figure 1: KBox A-150-BYT



---

The KBox A-150-BYT is factory configured to meet customer requirements. Kontron does not recommend opening the product as this may cause damage to internal components.

---



### 3/ Compliance

The KBox A-150-BYT complies with the relevant requirements and the approximation of the laws relating to 'CE' (for no Wi-Fi variant) and 'RED' (for Wi-Fi variant), and the standards that are constitutional parts of the declaration.

Table 1: Standards, Certifications and Directives Compliance

CE-Mark Compliant with EU Directives	Electromagnetic Compatibility	Directive 2014/30/EU
	Low Voltage	Directive 2014/35/EU
	Radio Equipment Directive (RED)	Directive 2014/53/EU
	RoHS II	Directive 2011/65/EU
EMC 2014/30/EU Emission	CISPR 11 EN 55011	Industrial, scientific and medical equipment - Radio-frequency disturbance characteristics - Limits and methods of measurement
EMC 2014/30/EU Immunity	EN 61000-6-2	Electromagnetic compatibility (EMC), part 6-2: Generic standards- Immunity for industrial environment
EMC 2014/53/EU	EN 301 489-1 V2.2.0	Electro-Magnetic Compatibility (EMC) standard for radio equipment and services; Part 1: Common technical requirements; Harmonized Standard covering the essential requirements of article 3.1(b) of Directive 2014/53/EU and the essential requirements of article 6 of Directive 2014/30/EU
EMC 2014/53/EU	<i>EN 301 489-17 V3.1.1</i>	Electro-Magnetic Compatibility (EMC) standard for radio equipment and services; Part 17: Specific conditions for Broadband Data Transmission Systems; Harmonized Standard covering the essential requirements of article 3.1(b) of Directive 2014/53/EU
RF Spectrum Efficiency & Spurious Emission 2014/53/EU	EN 300 328 V2.1.1	Wideband transmission systems; Data transmission equipment operating in the 2,4 GHz ISM band and using wide band modulation techniques; Harmonized Standard covering the essential requirements of article 3.2 of Directive 2014/53/EU
EMC CFR 47 Part 15, Subpart B	ANSI C63.4 CISPR 16 ICES-003	The American National Standards Institute standard ANSI C63.4 is the key standard for measuring electrical and electronic equipment for showing compliance to FCC and Industry Canada regulations.
Safety 2014/35/EU	IEC 61010-1 EN 61010-1 UL 61010-1	Safety requirements for electrical equipment for measurement, control and laboratory use - Part 1: General requirements
	IEC 61010-2-201 EN 61010-2-201 UL 61010-2-201	Safety requirements for electrical equipment for measurement, control and laboratory use - Part 2-201: Particular requirements for control equipment
Safety and Health 2014/35/EU	EN 62311	Assessment of the compliance of low power electronic and electrical equipment with the basic restrictions related to human exposure to electromagnetic fields (10 MHz to 300 GHz)

WEEE 2002/96/EC	Waste Electrical and Electronic Equipment Directive (WEEE Directive)	Compliant with the Waste Electrical and Electronic Equipment (WEEE) directive to reduce waste of electrical and electronic equipment, encourage recycling and environmental disposal and increase the environmental awareness of producers
--------------------	--	--



If the product is modified, the prerequisites for specific approvals may no longer apply.

---



Kontron is not responsible for any radio television interference caused by unauthorized modifications of the delivered product or the substitution or attachment of connecting cables and equipment other than those specified by Kontron. The correction of interference caused by unauthorized modification, substitution or attachment is the user's responsibility.

---



The use of shielded I/O cables is required when connecting to peripheral or host devices. Failure to do so may violate FCC/ICES rules.

---

## 4/ Shipment and Unpacking

### 4.1. Packaging

All parts are delivered together in a product specific cardboard package designed to provide adequate protection to absorb shock. Kontron recommends keeping the packaging to store or transport the product.

### 4.2. Unpacking

Proceed as follows to unpack the unit:

1. Remove packaging.
2. Do not discard the original packaging. Keep packaging for future relocation or storage.
3. Check the delivery for completeness by comparing it with the original order.
4. Keep the associated paperwork. It contains important information for handling the unit.
5. Check the contents for visible shipping damage.
6. If you notice any shipping damage or inconsistencies between the contents and the original order, contact Kontron for help and information.

### 4.3. Scope of Delivery

Check that your delivery is complete, and contains the items listed below. If you discover damaged or missing items, contact your dealer.

**Table 2: Scope of Delivery**

Delivered Item	Description
KBox A-150-BYT	Corresponding to the ordered product configuration
DIN Rail Clamp	DIN rail clamp installed on the rear side using 2x M4x6 screws
Phoenix Power connector	3-pin mating power connector/terminal (PSC 1,5/ 3-F) in DSUB 9 housing

### 4.4. Accessories

**Table 3: Accessories**

Part	Part Description
Power Supply 24 V	External AC/DC PSU with 50 W, 24 VDC at 40°C
Power Connector (3-pin)	Phoenix mating power connector/terminal (PSC 1,5/ 3-F) in DSUB 9 housing
Power Cable	Power cable AC mains to external adapter, Europe, UK and USA
HDD/SSD extension frame	Adjusts rives installation height from 7 mm to 9 mm
Heatsink kit	Heatsink with 4 screws (M4x8)

### 4.5. Optional Parts

- ▶ External accessible drive bay for one 2.5" SATA HDD/SSD drive
- ▶ Internal drive bay for mSATA SSD

### 4.6. Optional System Expansion

- ▶ 1x mSATA socket for memory expansion (internal)
- ▶ 1x mPCIe socket (Internal)

## 4.7. Kontron Optional mPCIe Modules

- ▶ APPROTECT mPCIe module
- ▶ WLAN mPCIe module

## 4.8. Type Label and Product Identification

The type label contains the following information.

Figure 2: KBox A-150-BYT Type Label

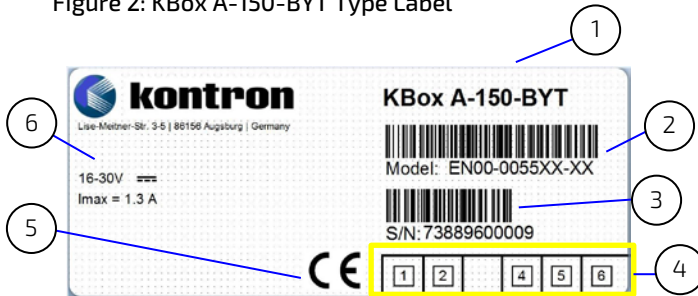

1. Product name (KBox A-150-BYT)
2. Model number with barcode
3. Serial Number (S/N) with barcode
4. For internal product use
5. Certification information
6. Technical data

## 5/ Product Overview

The KBox A-150-BYT is flexible industrial grade box PC fanless device designed for use in performance demanding applications requiring a flexible rapid rail attachment solution. Based on the Intel® Baytrail Celeron platforms, the KBox A-150-BYT features long-term availability and supports a varied amount of onboard interfaces to enable connectivity to nearly all applications. An Internal mSATA sockets support memory expansion and an internal mPCIe sockets supports expansion cards.

All variants are available in a robust steel chassis, designed for operation in a DIN rail environment using either a horizontal and vertical orientation. The chassis height differs depending on whether an external 2.5" HDD/SSD drive bay is installed on the side of the chassis, see Figure 3: KBox A-150-BYT Chassis Variants.

Figure 3: KBox A-150-BYT Chassis Variants



With external 2.5" HDD/SDD drive bay



---

The KBox A-150-BYT is designed for operation in a DIN rail environment using either a horizontal and vertical orientation. For more information, see Chapter 9/ Installation Instructions.

---

## 5.1. Front Panel Views

The front panel includes all I/O connectors. The position of the protective earth stud bolt varies depending on whether an external 2.5" HDD/SSD drive bay is supported.

Figure 4: Front Panel View (External HDD/SSD drive bay)

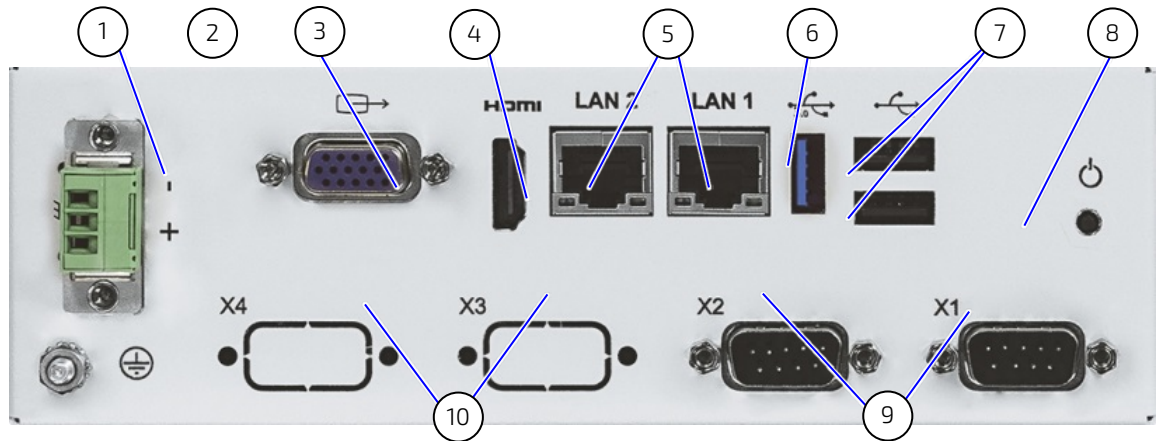

- |   |                            |    |                 |
|---|----------------------------|----|-----------------|
| 1 | Power connector            | 6  | USB 3.0         |
| 2 | Protective Earth stud bolt | 7  | 2x USB 2.0      |
| 3 | VGA connector              | 8  | Power-on switch |
| 4 | HDMI connector             | 9  | 2x Serial ports |
| 5 | 2x LAN connector           | 10 | 2x Breakouts    |

Figure 5: Front Panel (No External HDD/SSD drive bay)

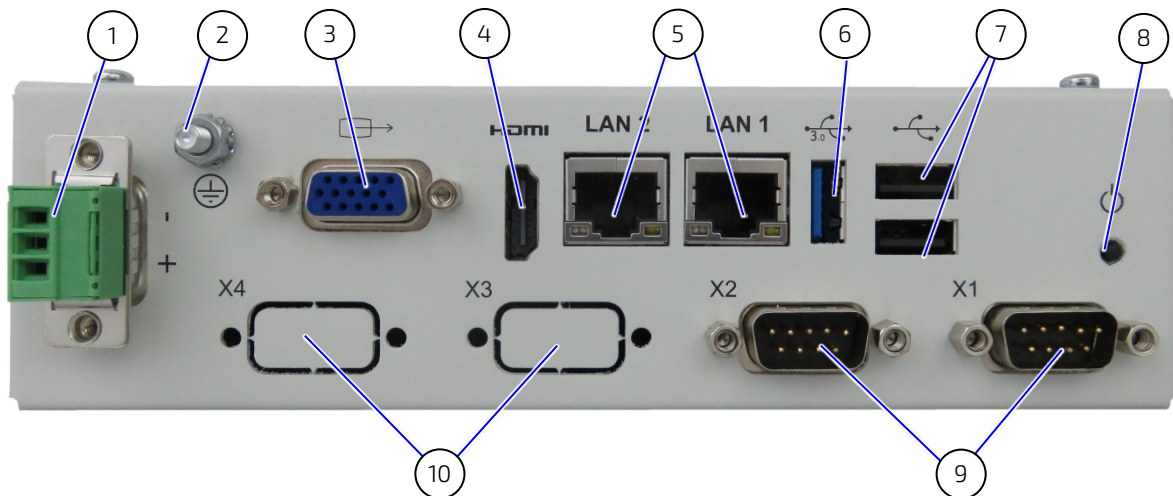

- |   |                            |    |                 |
|---|----------------------------|----|-----------------|
| 1 | Power connector            | 6  | USB 3.0         |
| 2 | Protective Earth stud bolt | 7  | 2x USB 2.0      |
| 3 | VGA connector              | 8  | Power-on switch |
| 4 | HDMI connector             | 9  | 2x Serial ports |
| 5 | 2x LAN connectors          | 10 | 2x Breakouts    |

### 5.1.1. Input Power Connector

There is one 3-pin input power connector on the front panel supporting an input DC voltage range of 9 to 30 VDC. The mating power connector/terminal required to connect the power connector to a DC main power supply, is supplied with the KBox A-150-BYT, (refer to Chapter 4.3: Scope of Delivery). For information on how to connect the supplied mating power connector/terminal to the front panel input power connector, refer to Chapter 9.2: Wiring the Mating Power Connector/Terminal.

For the pin assignment of the power connector, refer to Chapter 12.2.1: Input Power Connector.

### 5.1.2. Protective Earth Stud Bolt

There is a protective earth stud bolt on the front panel connected to the chassis GND inside the product. The position of the protective earth stud bolt varies depending on whether the KBox A-150-BYT is delivered with an external HDD/SSD drive bay, see Figure 4 (pos. 2) or without an external HDD/SSD drive bay, refer to Figure 5 (pos. 2).

### 5.1.3. VGA

There is one VGA graphics port for video only solutions, see Figure 4 (pos.3).

For the pin assignment of the VGA connector, refer to 12.2.2: VGA DB15 Connector.

### 5.1.4. HDMI (HDMI)

There is one HDMI port for video/audio solutions, see Figure 4 (pos.4).

For the pin assignment of the HDMI connector (HDMI1), refer to 12.2.3: HDMI Connector.

### 5.1.5. Ethernet (LAN1, LAN2)

There are two LAN ports LAN1 and LAN2 both supporting 10/100/1000 Mbit Ethernet, see Figure 4 (pos.5).

For the pin assignment of the RJ45 Ethernet connectors, refer to 12.2.4: GbE LAN1 RJ45 Connectors

### 5.1.6. USB 3.0

There is one USB 3.0 port allowing for the connection of USB 3.0 or USB 2.0 compatible device, see Figure 4 (pos.6).

For the pin assignment of the USB 3.0 connector, refer to Chapter 12.2.5: USB 3.0 Connector

### 5.1.7. USB 2.0

There are two USB 2.0 allowing for the connection of two USB 2.0 compatible devices using a USB 2.0 Type A connector, see Figure 4 (pos.7).

For the pin assignment of the USB 2.0 connector, refer to Chapter USB 2.0 Type A Connector.

### 5.1.8. Power-On

There is a power-on switch on the front panel to apply power or perform an orderly shutdown, see Figure 4 (pos.8).

### 5.1.9. Serial Ports (X1, X2) and (option X3, X4)

There are two serial ports COM1 and COM2 both supporting RS232/422/485, .see Figure 4 (pos.9). Additionally, there are two breakouts for optional RS232 only serial ports, see Figure 4 (pos.10).

For the pin assignment of the serial port connectors COM1 and COM2, refer to Chapter 12.2.7: COM1, COM2 RS-232/422/485 Connectors .

### 5.2. Rear View

Figure 6: Rear View

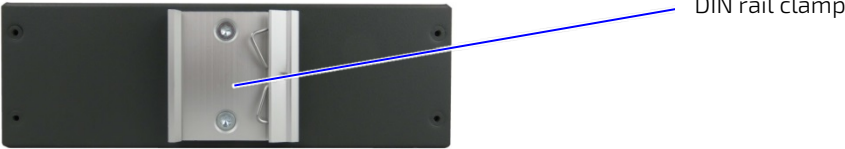

### 5.3. Top and Bottom View

Figure 7: Top and bottom View

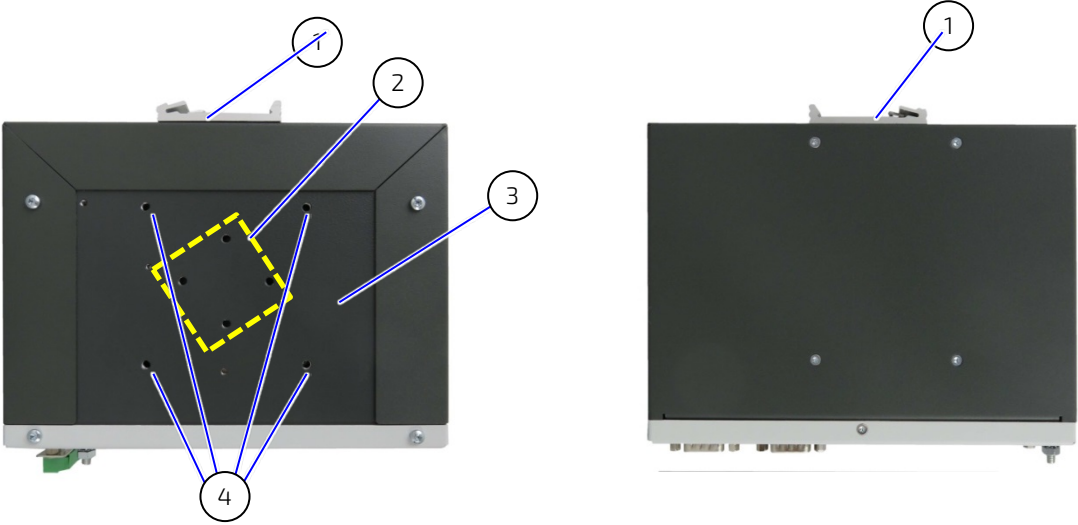

- 1 Din rail clamp
- 2 2x Din rail mounting hole pairs for (horizontal or vertical) Max. M4 x 6 mm
- 3 Heat sink plate

- 4 4x Mounting holes for heat sink fins



## 5.4. Side Views

The 2.5" HDD/SSD drive bay is accessible on the side of the KBox A-150-BYT. The height of the chassis depending on whether the KBox A-150-BYT is supplied with or without the 2.5" HDD/SSD drive bay. The height of the side is 58 mm high with 2.5" HDD/SSD drive bay and 50 mm high without 2.5" HDD/SSD drive bay.

Figure 8: Side View

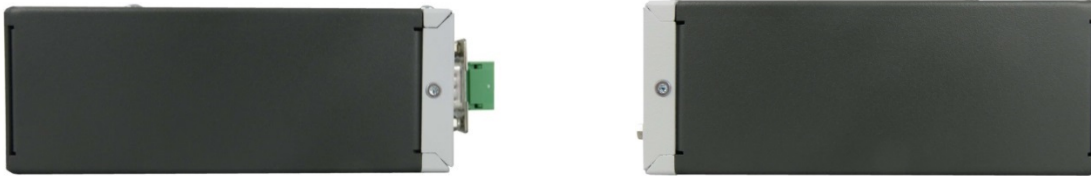

Figure 9: Side Views with 2.5" HDD/SSD Drive Bay



## 6/ System Extension



---

The KBox A-150-BYT is factory configured to meet customer requirements. Kontron does not recommend opening the product to install expansion card as this may cause damage to internal components.

---

### 6.1. Storage

#### 6.1.1. External HDD/SSD Drive Bay

To expand storage memory for variants with an external HDD/SSD Drive Bay, use a 2.5" slim SSD. Before installing or removing an existing external SSD, refer to Chapter 7.1: Accessing External Components.



---

Pay attention to the manufacturer's lifespan specification. Due to the limited lifespan of HDD/SSD drives Kontron recommends checking the condition of installed HDD/SSD drives via S.M.A.R.T.regularly.

---

#### 6.1.2. Internal mSATA SSD

To expand storage memory an internal mSATA SSD of up to 512 GBytes can be installed. Kontron recommends the use of Kontron reference SSDs from 32 GB to 512 GB. For information regarding the pin assignment of the mSATA socket, refer Chapter 12.4.8: mSATA Socket Serial ATA port 1- Full Size.

Before installing or removing an existing internal mSATA SSD, refer to Chapter 7.2.2: Installing and Removing Internal mSATA SSD.



---

Pay attention to the manufacturer's lifespan specification. Due to the limited lifespan of HDD/SSD drives Kontron recommends checking the condition of installed HDD/SSD drives via S.M.A.R.T.regularly.

---

### 6.2. Expansion Cards - mPCIe

There is one internal mini PCIe V 1.2 expansion socket. For information regarding the pin assignment of the mPCIe expansion socket, refer Chapter 12.4.7. mPCIe Express V 1.2 Socket -Full Size.

Before installing or removing an mPCIe expansion card, refer to Chapter 7.2.3: Installing and Removing mPCIe Expansion Cards.

## 7/ Accessing Components

This chapter contains important information that users must read before accessing components. Follow these procedures properly when accessing or installing components.



---

The KBox A-150-BYT is factory configured to meet customer requirements. Kontron does not recommend opening the product as this may cause damage to internal components.

---

### **⚠ WARNING**

---

The installation/removal of internal components may only be performed by qualified persons. Observe the "General Safety Instructions" and the "Installation Instructions" contained within this user guide.

---



#### ESD Sensitive

---

Follow the safety instructions for components that are sensitive to electrostatic discharge (ESD). Failure to observe this warning notice may result in damage to the product or/and internal components.

---



---

Because of the limited predetermined lifespan of expansion devices, Kontron recommends checking the condition of installed expansion devices regularly and to pay attention to the manufacturer specifications for lifespan.

---

## 7.1. Accessing External Components

### 7.1.1. HDD/SSD Drive Bay

The KBox A-150-BYT variant including a 2.5" HDD/SSD drive bay supports the use of 9.5 mm and 7 mm high SSD drives in the 2.5" HDD/SSD drive bay. To insure that 7 mm high SSDs are correctly connected and to avoid damage to the internal SATA connectors a spacer must be attached to the 7 mm SSD drive to enable the 7mm SSD drives to correctly align with the internal SATA data and SATA power connector mounting points.

To remove/install a removable 2.5" HDD/SSD drive, perform the following steps:

1. Press the eject button on the right hand side of the HDD/SSD drive bay, to remove an existing HDD/SSD drive from the HDD/SSD Drive Bay.
2. The HDD/SSD drive bay springs open and the HDD/SSD drive automatically slides out a bit for removal.
3. Remove the drive by holding the sides and carefully pulling the drive out of the HDD/SSD drive bay.



---

The 2.5" HDD/SSD drive bay allows for the installation of 9.5 mm or 7 mm high SSDs. A 7 mm high SSD can only be used, when a spacer is attached to the drive. The spacer ensures that a 7 mm high SSD drive is correctly aligned with the internal SATA data and SATA power connector mounting points.

---

4. For 9.5 mm high SSDs, carefully push the drive into the drive bay with the SSD contacts facing the drive bay and the drive facing downward until the connectors attach.

For 7 mm high SSDs, attach the SSD to a 7 mm – 9.5 mm spacer, then carefully push the SSD with spacer into the drive bay with the SSD contacts facing the drive bay until the connectors attach.

5. The KBox A-150-BYT can now be powered up.

## 7.2. Accessing Internal Components

### 7.2.1. Opening the Chassis

To access the internal components, open the KBox A-150-BYT chassis by following the step below:



The KBox A-150-BYT is factory configured to meet customer requirements. Kontron does not recommend opening the product as this may cause damage to internal components.

1. Close all applications. Shut down the product properly and disconnect the power cord from the power supply. Disconnect all peripherals
2. Place the KBox A-150-BYT on a flat, clean and ESD-safe surface.
3. The front panel is attached to the mainboard. To remove the front panel and open the chassis the main board must also be released. To release the mainboard remove the two screws shown in Figure 10: Mainboard Fastening Screws.

Figure 10: Mainboard Fastening Screws

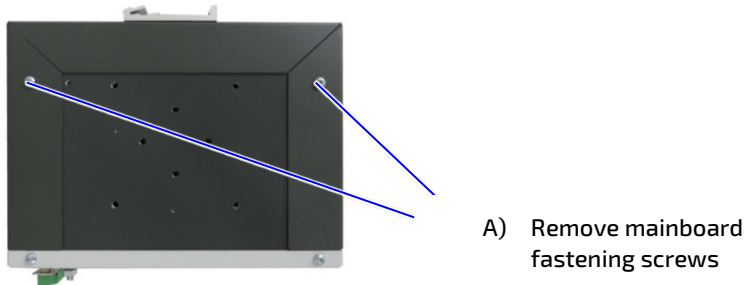

4. To release the front panel remove the five screws that fasten the front panel to the main chassis, see Figure 11: Front Panel Fastening Screws. One screw is located at the bottom of the front panel, two screws are located on the front panel's sides (right and left) and a further two screws are located on the front panel's top side. Retain all screws, to refasten the front panel to the main chassis.

Figure 11: Front Panel Fastening Screws

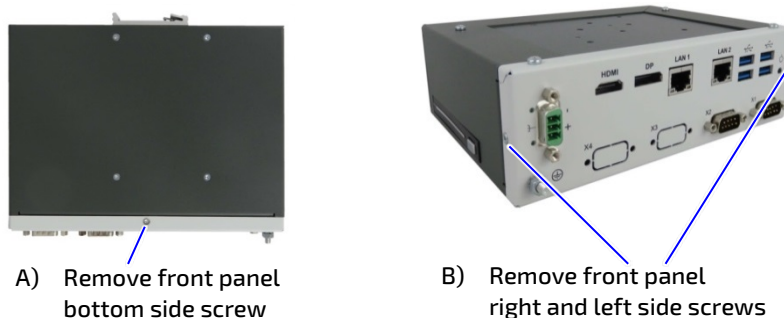

5. Once released, carefully move the front panel away from the main chassis while taking care not to damage the attached main board. Place the front panel plus mainboard construction on an ESD-safe surface.
6. To close the KBox A-150-BYT, proceed in the reverse order. Align the front panel with the main chassis and push towards the rear side of the chassis while making sure that the front panel remains aligned and goes back until the screw holes are aligned. Secure the cover with the screws removed in step 4 and step 3.

## 7.2.2. Installing and Removing Internal mSATA SSD



---

The KBox A-150-BYT is factory configured to meet customer requirements. Kontron does not recommend opening the product as this may cause damage to internal components.

---

To install a mSATA SSD follow the steps below:

1. Close all applications, shut down the product properly, and disconnect the connection to the power supply. Disconnect all peripherals.
2. Open the chassis as described in Chapter 7.2.1: Opening the Chassis (steps 1-5).
3. Locate the mSATA sockets and the corresponding fixing screw hole.
4. Insert the mSATA SSD card into the sockets at an angle of approx. 30° and push it down until the fixing holes on the card are aligned with the mainboard's fixing screw hole.
5. Secure the mSATA by pressing down on the free end and carefully screw the mSATA card to the mainboard until the mSATA card is flat with the mainboard.
6. To close the KBox A-150-BYT, proceed in reverse order (step 6 to 1) of Chapter 7.2.1: Opening the Chassis.

To remove a mSATA SSD follow the steps below:

1. Close all applications, shut down the product properly, and disconnect the connection to the power supply. Disconnect all peripherals.
2. Open the Chassis as described in the Chapter 7.2.1: Opening the Chassis (steps 1-5).
3. Locate the mSATA SSD card installed into your product.
4. Remove the fastening screw and the mSATA SSD springs up at an angle of approximately 30° at the free end.
5. Gently pull the mSATA SSD card out of the mSATA socket.
6. To close the KBox A-150-BYT, proceed in reverse order (step 6 to 1) of Chapter 7.2.1: Opening the Chassis.

---

**⚠ WARNING**

After changing the mSATA SSD the partitioning of the memory maybe different.

---

### 7.2.3. Installing and Removing mPCIe Expansion Cards



---

The KBox A-150-BYT is factory configured to meet customer requirements. Kontron does not recommend opening the product as this may cause damage to internal components.

---

To install a mini PCIe card follow the steps below:

1. Close all applications, shut down the product properly, and disconnect the connection to the power supply.
2. Disconnect all peripherals.
3. Open the device as described in the Chapter 7.2.1: Opening the Chassis (steps 1-5).
4. Locate the mini PCIe card socket and the corresponding fixing screw hole.
5. Insert the mini PCIe card into the socket at an angle of approx. 30° and push it down until the fixing holes on the card are aligned with the mainboard's fixing screw hole. fixing clips.
6. Secure the mPCIe by pressing down on the free end and carefully screw the mPCIe card to the mainboard until the mPCIe card is flat with the mainboard.
7. To close the KBox A-150-BYT, proceed in reverse order (steps 6 to 1) of Chapter 7.2.1: Opening the Chassis.

To remove a mini PCIe card follow the steps below:

1. Close all applications, shut down the product properly, and disconnect the connection to the power supply. Disconnect all peripherals.
2. Open the device as described in the Chapter 7.2.1: Opening the Chassis (steps 1-5).
3. Locate the mini PCIe card installed into your product.
4. Remove the fastening screw and the mPCIe card springs up at an angle of approximately 30° at the free end.
5. Gently pull the mini PCIe card out of the socket.
6. In order to close the KBox A-150-BYT, proceed in reverse order (steps 6 to 1) of Chapter 7.2.1: Opening the Chassis.

## 8/ Thermal Considerations

### **⚠ WARNING**

#### Hot Surface - heatsink

Danger of burns. Heatsink can get very hot. To avoid burns and personal injury:

- ▶ Do not touch the heatsink when the product is in operation
- ▶ Allow the product to cool before handling
- ▶ Wear protective gloves
- ▶ Always turn the product off when not in use

### 8.1. Heatsink

The KBox A-150-BYT is a fanless and passively cooled using a heatsink plate to dissipates heat from within the KBox A-150-BYT's chassis to the ambient environment. When mounting the KBox A-150-BYT in a DIN rail enclosure or housing take care not to obstruct the airflow over the heatsink plate, as this stops sufficient heat dispersing into the ambient environment and causes a build-up of heat.

Features of the heatsink plate are:

- ▶ Surface area of 171 mm x 105 mm

### 8.2. Heatsink (Optional)

The heatsink is installed on top of the heatsink plate. It is possible to rotate the heatsink by 90° to enable the heatsink to remain in the vertical position to support vertical airflow within a DIN rail control cabinet. The DIN rail clamp can be installed directly on the top of the heatsink.

Figure 12: Heatsink and heatsink with DIN Rail Clamp



When mounting in a DIN rail control cabinet, take care not to obstruct the airflow over the heatsink. Obstructing the airflow can stop sufficient heat dispersing into the ambient environment and causes a build-up of heat.

The heatsink dimensions are:

- ▶ 130 mm (5.12"), 130 mm (5.12"), 19.2 mm (0.76")



The Heatsink Kit's part number is EN05-100003-01.

## 9/ Installation Instructions



Expansion card installation should be performed before installing the KBox A-150-BYT into the control cabinet.

### 9.1. DIN Rail Mounting

The KBox A-150-BYT is a rail mount PC box designed for use in a DIN rail enclosure or housing by attaching a DIN rail mounting clamp. The DIN rail mounting clamp can be attached on the:

- ▶ Top side of the chassis
- ▶ Heat sink on the top side of the chassis
- ▶ Rear side of the chassis

The position and direction of the clamp decides the orientation of the product within the DIN rail enclosure or housing. When deciding on the KBoxA-150-BYT's orientation consider access to the front panel and to the external 2.5" HDD/SDD drive bay, if available.

To attach the DIN Rail retaining clamp, follow the steps below:

1. Make sure that the DIN Rail retaining clamp is in the upper position, for the required mounting option.

Figure 13: DIN Rail Retaining Clamp Upper Position



2. Fasten the DIN rail mounting clamp firmly to the chassis using two M4x6 (Max. length) counter sunk screws.

Figure 14: DIN Rail Mounting Clamp Screw Dimensions (Measurements in mm)

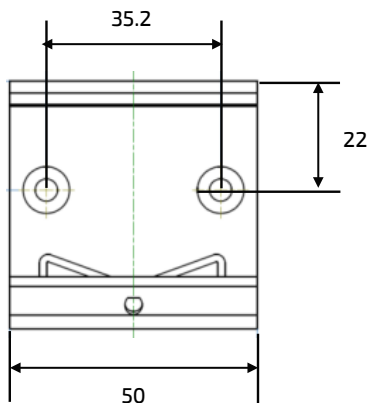

3. Clip the top of the DIN rail mounting clamp in to the DIN rail and push the bottom of the DIN rail firmly until it clamps on to the bottom of the DIN rail.



## 9.2. Wiring the Mating Power Connector/Terminal

The KBox A-150-BYT is connected by the input power connector to a DC power supply via a DC power supply wiring; consisting of the mating power connector/terminal (3-pin Phoenix PSC 1,5/ 3-F) delivered with the KBox A-150-BYT and assembled wires. The wiring is inserted into the mating power connector/terminal's clamps, see Figure 15, pos. 3, 4 & 5 and must be clearly marked (+/-/functional earth) to ensure proper connection to the DC power supply.

The wiring is not part of the delivery and must be provided by the user.

- ▶ Use copper conductors only if the field wiring terminal is only for connection to copper wire.
- ▶ Minimum temperature rating of the cables connected to the field wiring terminals is 75° C.

Figure 15: Mating Power Connector/Terminal

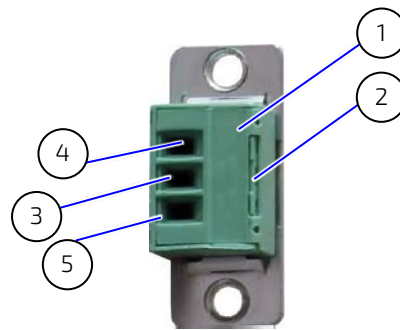

- |   |  |   |                                      |
|---|--|---|--------------------------------------|
| 1 | 3-pin mating power connector/terminal            | 4 | Location for inserting the 0 V wire  |
| 2 | Cover over the slotted pan head screws           | 5 | Location for inserting the 24 V wire |
| 3 | Location for inserting the functional earth wire |   |                                      |

To wire the supplied 3-pin Phoenix (PSC 1,5/ 3-F) mating power connector/terminal, following the step below.

1. Cut three (1 mm<sup>2</sup>) AWG18 isolated wires to the required length and strip each end 5 mm – 7 mm.
2. Twist the striped wire ends and provide them with ferrules.
3. Access the slotted pan head screws by opening the mating power connector/terminal's cover (Figure 15, pos. 2).
4. Loosen the slotted pan head screws far enough so that you can insert the end of the prepared wires.
5. Insert the wires into the corresponding clamp of the mating power connector/terminal. Make sure that you have the right polarity of the connection. For the pin assignment of the Input power connector, refer to Chapter 12.2.1: Input Power Connector.
6. Fasten the screws to secure the wires into the mating power connector/terminal's clamps.
7. Close the mating power connector/terminal cover (Figure 15, pos. 2).

### NOTICE

Mark the wires clearly as (+/-/functional earth) to ensure a safe connection from the input power connector to the DC power supply.

### NOTICE

Support the power and I/O cables to minimize the strain on the product's connectors.

## 10/ Starting Up

Before using the KBox A-150-BYT, become familiar with the product and follow the startup instructions below.

### 10.1. Connecting to an External DC Power Supply

The KBox A-150-BYT connects to a DC power supply via a power connector/terminal and corresponding wiring.

#### ⚠ CAUTION

Observed that wiring and short-circuit/overcurrent protection is performed according to the applicable standards, regulations and in respect to the product's electrical specification. The disconnecting device (fuse/circuit breaker) rating must be in accordance with the product wire cross-section.

#### ⚠ CAUTION

Even when switched off using the power-on switch, parts of the product are still energized. The product is only completely switched off when the power has been switched off using the power-on switch and the power cable is disconnected from either the DC power supply or the Input power connector.

#### NOTICE

Following a proper cabling procedure prevents a false power-on condition, that could result in operational failure. When installing/disconnecting the product ensure that:

- The functional earth connection is made first and disconnected last.
- The last connection made to the product is the power wiring.

#### NOTICE

The wires used for power connections must be marked clearly (+/-/functional earth) to ensure a safe connection from the input power connector to the DC power supply.

#### NOTICE

Support the power and I/O cables to minimize the strain on the product's connectors.

#### NOTICE

Do not disconnect the power while the product is switched on! This performs a forced shutdown and can lead to loss of data. To shutdown without data loss, switch off using the Power-on switch.

To connect to the external DC power supply, perform the following:

1. Ensure that the DC power supply is switched off via a disconnecting device (circuit breaker), in order to ensure that no power is flowing from the external DC power supply during the connection procedure.
2. Connect the protective earth stud bolt to an appropriate common earth connection point.
3. Connect the wired mating power connector/terminal (PSC 1.5/3-F) to the input power connector. Pay attention to the polarity of the connections, see Chapter 12.2.1: Input Power Connector.
4. Connect the other end of the DC power cable to the DC main power supply.
5. Switch on the disconnecting device (circuit breaker) in order to apply voltage to the KBox-A-150-BYT.



Once connected to an external DC power supply the KBox A-150-BYT can be switch on and switch off using the front panel power-on switch.

### 10.1.1. Switch On

A Power-on switch is available on the front panel, to apply power or perform an orderly shutdown without data loss see Figure 5: Front Panel (pos.8).

---

**NOTICE**

Do not disconnect the power while the product is switched on. This performs a forced shutdown and can lead to loss of data. To shutdown without data loss, switch off using the Power-on switch

---

**CAUTION**

Even when switched off using the power-on switch, parts of the product are still energized. The product is only completely switched off when the power has been switched off using the power-on switch and the power wiring is disconnected from either the DC power supply or the Input power connector.

---

## 10.2. Operating System (OS) and Drivers

The standard KBox-A-150-BYT is fully operational when switched on for the first time with pre-installed OS and drivers. Drivers are available from Kontron's [Customer Section](#).

If ordered without pre-installed OS you will need to install the operating system and the appropriate drivers for the system configuration ordered, before starting the KBox-A-150-BYT.

# 11/Technical Data

## 11.1. Block Diagram

Figure 16: Block Diagram

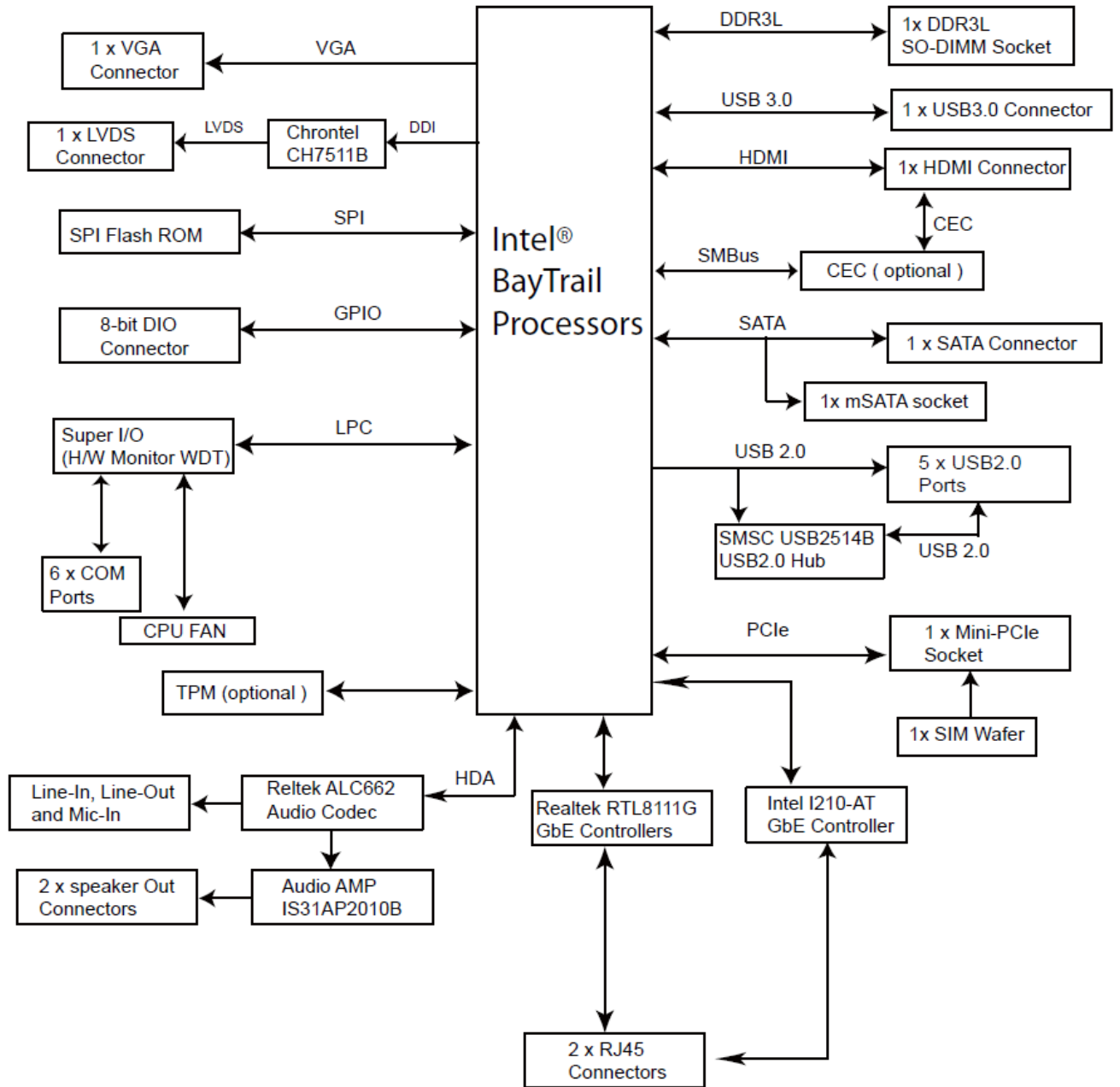

## 11.2. Technical Specification

The KBox A-150- BYT implements the following mainboard technical specification.

**Table 4: Technical Specification**

<b>Processor</b>	Intel® BayTrail Celeron® Quad Core J1900 2.0 GHz/2.4 GHz (Burst)
<b>System Memory</b>	1x DDR-3L 1333 SODIMM 4 GB RAM (up to 8 GB Max.)
<b>Storage</b>	64 GB mSATA SSD as default (option for up to 512 GB) External SSD Drive bay/ Internal mSATA SSD
<b>Graphics</b>	Intel® HD Graphics
<b>Audio</b>	Realtek ALC 662
<b>Interfaces</b>	2x USB 2.0 1x USB 3.0 2x LAN (GbE) 1x HDMI 1x VGA 2x COM ( RS 232, RS422, RS485, BIOS configurable)
<b>Sockets</b>	1 x mSATA 1x mPCIe
<b>Power</b>	9 VDC - 30 VDC Input

**Table 5: Software Specification**

<b>Operating System (OS)</b>	Windows 7 for embedded systems (32 bit/64bit) and Windows 7 (WES) (64 bit) Windows 8.1 Pro (32 bit/64 bit) Windows 10 IoT Enterprise (64 bit) Linux
<b>BIOS</b>	AMI uEFI BIOS

## 11.3. Mechanical Specification

**Table 6: Mechanical Specification**

<b>Dimensions</b>	<b>KBox A-150-BYT (with 2.5" HDD/SSD Drive Bay)</b>	<b>KBox A-150-BYT (without 2.5" HDD/SSD Drive Bay)</b>
<b>Width</b>	180 mm (7.09")	180 mm (7.09")
<b>Depth</b>	134 mm (5.28")	134 mm (5.28")
<b>Height</b>	58 mm (2.28") without heatsink 76 mm (2.99") with heat sink	50 mm (1.97") without heatsink 68 mm (2.68") with heatsink
<b>Weight (chassis only)</b>	Approx. ~1 kg (~2.2 lbs.)	Approx. ~1 kg (~2.2 lbs.)
<b>Construction</b>	Steel chassis	Steel chassis
<b>Mounting</b>	DIN Rail	DIN Rail
<b>Color</b>	RAL7035 (Front panel) RAL7043 (Top cover and main chassis) Cooling fins, black	RAL7035 (Front panel) RAL7043 (Top cover and main chassis) Cooling fins, black

The following outline dimension drawings shows the main external mechanical features for the KBoxA-150-BYT with an external 2.5" HDD/SSD drive bay.

Figure 17: Front Panel Dimensions with HDD/SSD drive bay (Measurements in mm)

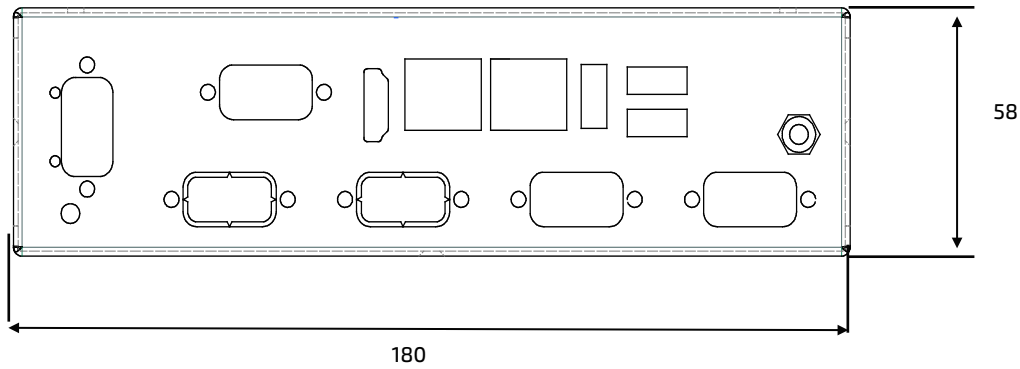

Figure 18: Rear Side Dimensions with HDD/SSD drive bay (Measurements in mm)

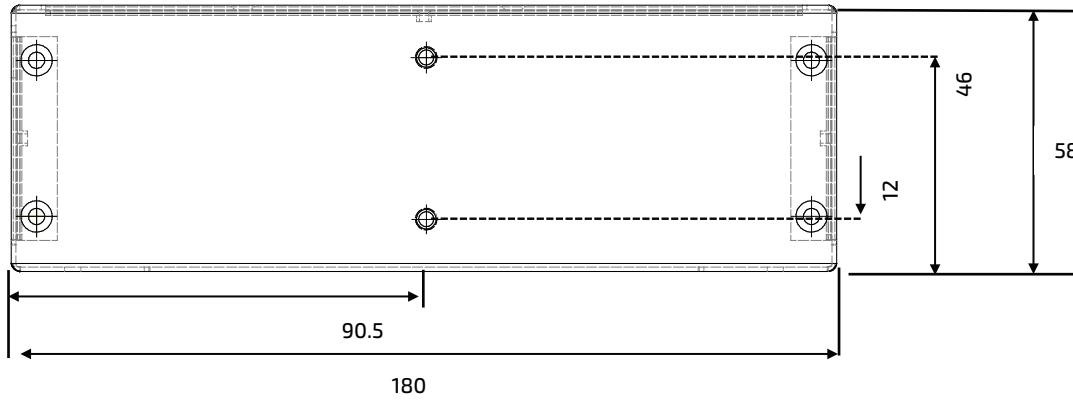

Figure 19: Top Side Dimensions with HDD/SSD drive bay (Measurements in mm)

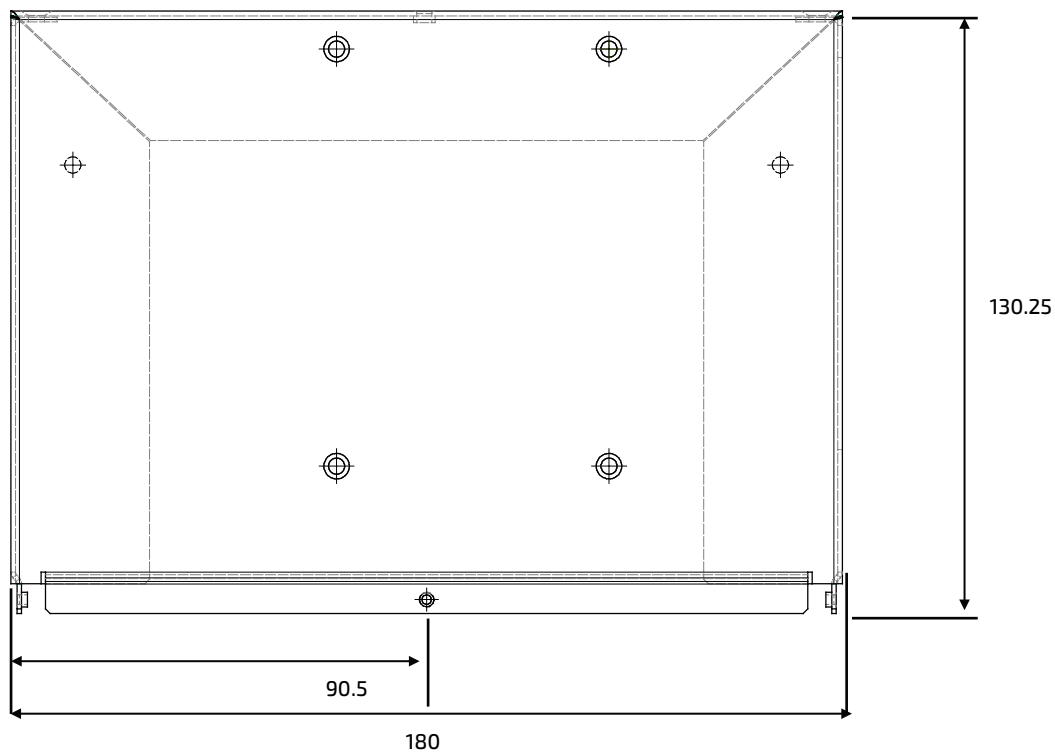
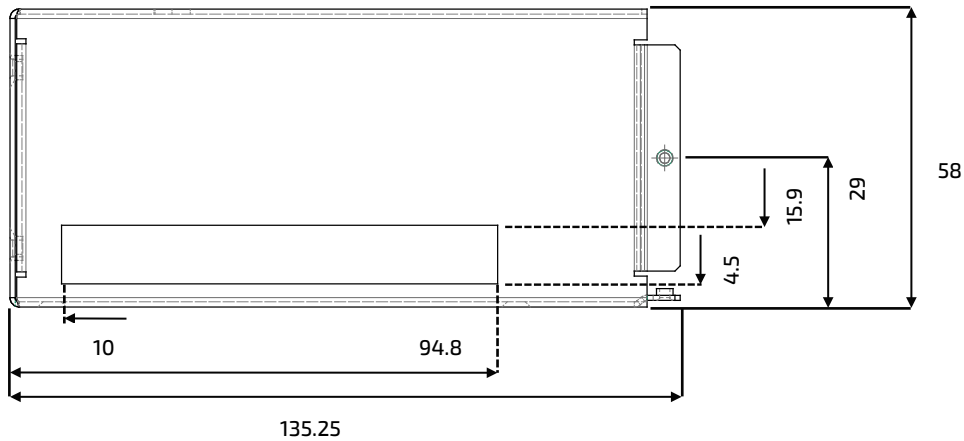

Figure 20: Side View Dimensions with HDD/SSD drive bay (Measurements in mm)



The following outline dimension drawings shows the main external mechanical features for the KBoxA-150-BYT without an external HDD/SSD drive bay. **All dimensions are shown in mm.**

Figure 21: Front Panel Dimensions without drive bay (Measurements in mm)

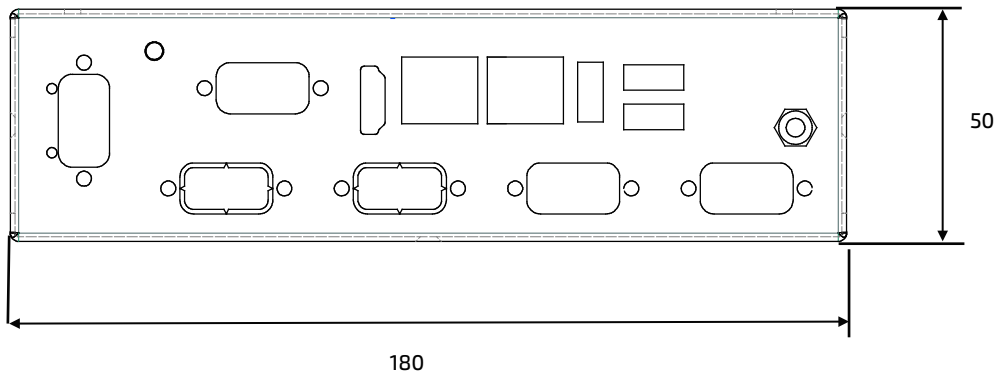

Figure 22: Rear Side Dimensions without drive bay (Measurements in mm)

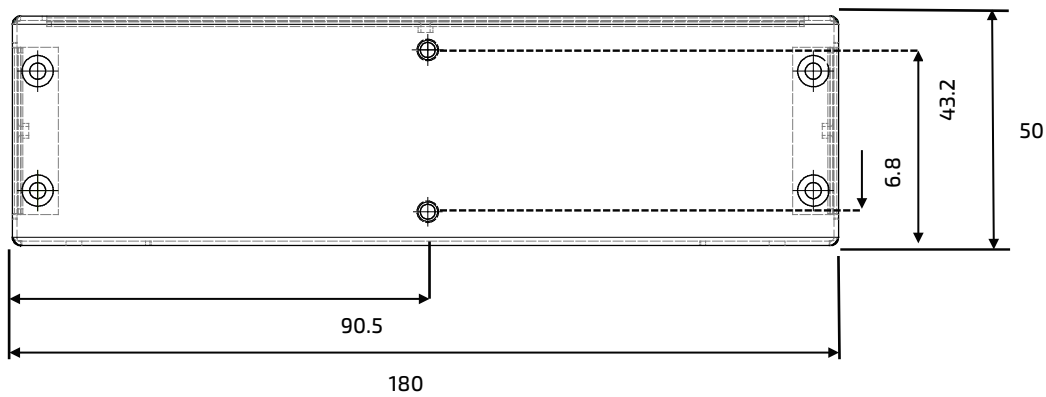

Figure 23: Top Side Dimensions without drive bay (Measurements in mm)

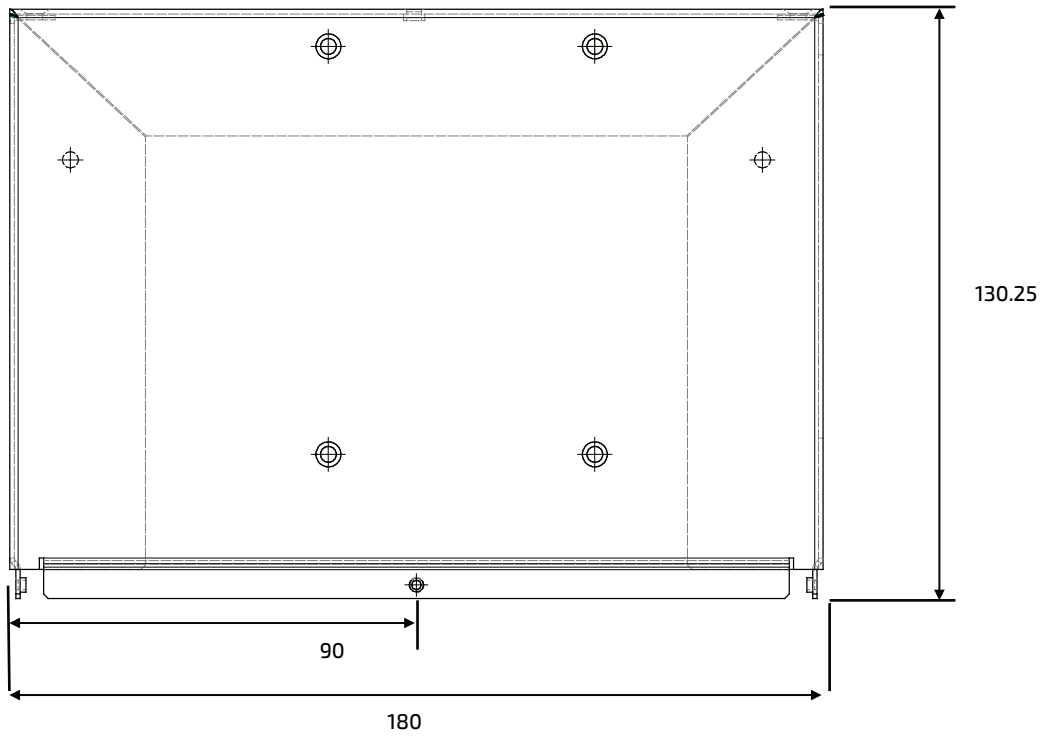
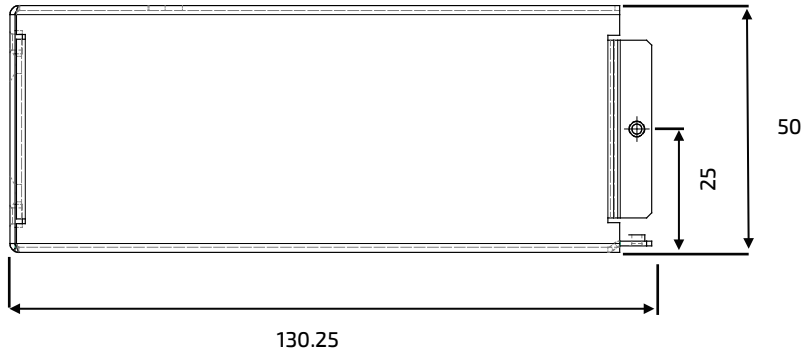

Figure 24: Side View Dimensions without drive bay (Measurements in mm)



## 11.4. Environmental Specification

Table 7: Environmental Specification

Temperature (Operating)	0°C - 50°C ambient without heatsink
Relative Humidity (Operating)	10%-90% RH @ 39°C, non condensing



## 11.5. Power Specification

Before connecting the product to a mains power supply ensure that the power supply meets the required electrical specification for the product and that protection and supply limitation have been taken into consideration. Additionally, the power supply used must automatically recover from AC power loss and start up under peak loading.

Connect the product only to a power supply designed to achieve NEC Class-2 and Limited Power Source (LPS).

Table 8: KBox A-BYT Electrical Specification

Nominal Input Voltage	24 V DC
Input Voltage Range	9 V DC to 30 V DC
Input Current	4.4 A (Max.)
Inrush Current	6 A
Input Power Connector	3- pin Phoenix PSC 1.5/3-M

### ⚠ CAUTION

Observed that wiring and short-circuit/overcurrent protection is performed according to the applicable standards, regulations and in respect to the product's electrical specification. The disconnecting device (fuse/circuit breaker) rating must be in accordance with the product's wire cross-section.

### ⚠ CAUTION

Only connect to an external power supply delivering the specified input rating and complying with the requirements of Safety Extra Low Voltage (SELV) and Limited Power Source (LPS) of UL/IEC 60950-1 or (PS2) of UL/IEC 62368-1.

### NOTICE

Ensure that the power supply is used according to the manufacturer's instructions.

### NOTICE

Ensure the power supply has been fully tested to at least meet the minimum immunity of AC inputs requirements, as stipulated in IEC 55024. Including power supplies marketed with a separate AC/DC power converter.

### 11.5.1. Power Supply Protection Requirements

The used external power supply is required to incorporate protection and supply features such as over current protection, inrush current protection, over voltage protection and under voltage (brownout) protection, to protect the product against fluctuations and interruptions in the delivered DC power supply.

### NOTICE

If an under voltage (brownout) condition occurs the used power supply must remain in the "off state" long enough to allow internal voltages to discharge sufficiently. Failure to observe this "off state" may mean that parts of the product or peripherals work incorrectly or suffer a reduction of MTBF. The minimum "off state", to allow internal voltages to discharge sufficiently, is dependent on the power supply and additional electrical factors. To determine the required "off state", each case must be considered individually. For more information, contact [Kontron Support](#).

## 11.5.2. Power Consumption

The used external power supply must be capable of delivering the product with the required power when configured with all components. The total power consumption depends on factors such as the SBC, interfaces, and system/memory expansion.

**Table 9: Power Consumption**

Power Consumption			Type Label Rating	
Mainboard (Burn-In)	External Interfaces	Total		
100% RAM, 100% CPU 100% Disk	1x USB 3.0 4x USB 2.0 1x HDMI	Mainboard + External Interfaces	Voltage	30 V to 9 V (Max. range)
			Current	4.4 A (Max.)
7.5W	16.9 W	24.4 W	Power	25.6 W (24.4 W + 5%)



---

The external power supply must supply power to all configured components.

---

## 11.5.3. Protective Earth Stud Bolt

The protective earth stud bolt connects to the internal chassis GND. The protective earth stud bolt is located next to the DC Input Power connector at the bottom of the front panel when the external 2.5" HDD/SSD drive bay is included (Figure 4, pos. 2) and at the top of the front panel without an external drive bay (Figure 5, pos. 2).

When installing cables to the product the first cable connection must be to the the protective earth stud bolt and when disconnecting the last cable to be disconnected must be from the protective earth stud bolt.

## 12/ Connector, Socket and Jumper Pin Assignments

Before changing, any hardware setting read this chapter carefully. This chapter provided information for the front panel connectors and the relevant internal connectors, sockets and jumpers.

### 12.1. Front Panel Connectors

Figure 25: Front Panel Connectors

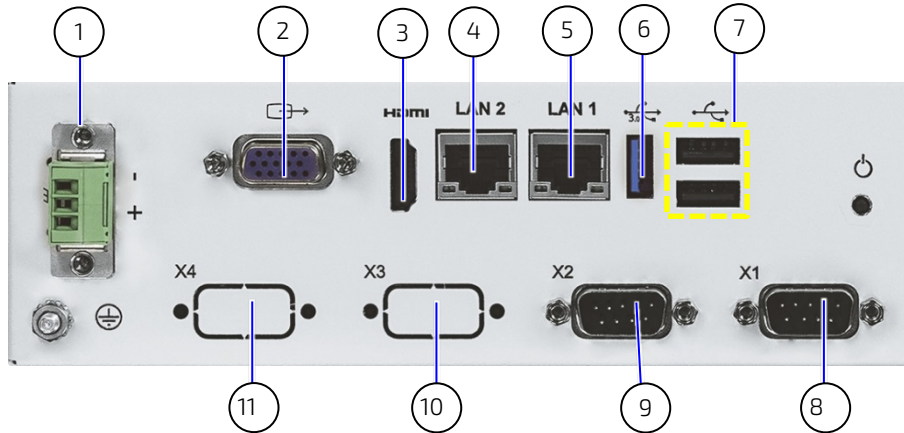

Table 10: Front Panel Connectors

Item	Function
1	DC Power Connector (3-pin Phoenix)
2	VGA Connector DB-15
3	HDMI Connector
4	GbE LAN1 RJ-45 Connector
5	GbE LAN2 RJ-45 Connector
6	USB 3.0 Connector
7	USB 2.0 Type A Connector
8	COM1
9	COM2
10	COM3
11	COM4

### 12.2. Front Panel Connector Pin Assignments

#### 12.2.1. Input Power Connector

3-Pin Power	Pin	Signal Name
	1	GND
	2	Functional earth
	3	VCC

### 12.2.2. VGA DB15 Connector

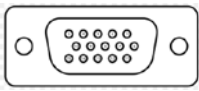
15-pin VGA	Pin	Signal Name	Pin	Signal Name
	1	Red	2	Green
	3	Blue	4	NC
	5	GND	6	GND
	7	GND	8	GND
	9	VCC	10	GND
	11	Nc	12	DDC Data
	13	Hsync	14	Vsync
	15	DDC clock		

### 12.2.3. HDMI Connector (HDMI)

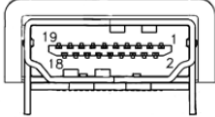
19-pin HDMI	Pin	Signal Name
	1	TMDS Data2+
	2	GND
	3	TMDS Data2-
	4	TMDS Data1+
	5	GND
	6	TMDS Data1-
	7	TMDS Data0+
	8	GND
	9	TMDS Data0-
	10	TMDS Clock+
	11	GND
	12	TMDS Clock-
	13	Reserved
	14	Reserved
	15	DDC_CLK
	16	DDC_DATA
	17	GND
	18	+5V Power
	19	Hot Plug Detect

### 12.2.4. GbE LAN1 RJ45 Connectors (LAN1, LAN2)

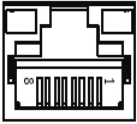
RJ45 (female)	Pin	Signal Name	Pin	Signal Name
	1	MDIO+	5	MDI2-
	2	MDIO-	6	MDI1-
	3	MDI1+	7	MDI3+
	4	MDI2+	8	MDI3-

Left LED: Speed		Right LED: Activity/Link	
Off	10 Mbit	Off	NO LAN connectivity
Green	100 Mbit	Yellow	Link
Orange	1 GbE	Blinking	Activity

### 12.2.5. USB 3.0 Port Connector

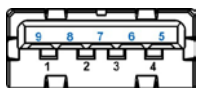
USB 3.0 Port	Pin	Signal Name	Pin	Signal Name
	1	+USB_VCC <sup>(1)</sup>	5	USB_RX-
	2	Data-	6	USB_RX+
	3	Data+	7	GND
	4	GND	8	USB_TX-
			9	USB_TX+

(1) The power source of +USBVCC can be selected by JP6.

### 12.2.6. USB 2.0 Type A Connector

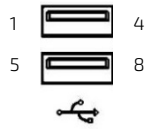
USB 2.0 Port	Pin	Signal Name	Pin	Signal Name
	1	+USB_VCC <sup>(1)</sup>	5	+USB_VCC <sup>(1)</sup>
	2	Data_A-	6	Data_B-
	3	Data_A+	7	Data_B+
	4	GND	8	GND

(1) Power source of +USBVCC can be selected by USB Power Selection jumper (JP6).

### 12.2.7. Serial Port Connectors (X1, X2)

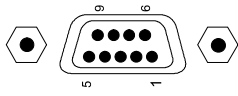
Serial Port	Pin	RS232	RS422	RS 485 Half Duplex	RS 485 Full Duplex
	1	DCD	Tx-	Data-	Tx-
	2	RxD	Tx+	Data+	Tx+
	3	TxD	Rx+		Rx+
	4	DTR	Rx-		Rx-
	5	GND	GND	GND	GND
	6	DSR			
	7	RTS			
	8	CTS			
	9	RI			

Note: X3 and X4 are RS232 only.

### 12.3. Internal Connectors and Sockets

Figure 26: Internal Connectors Top View

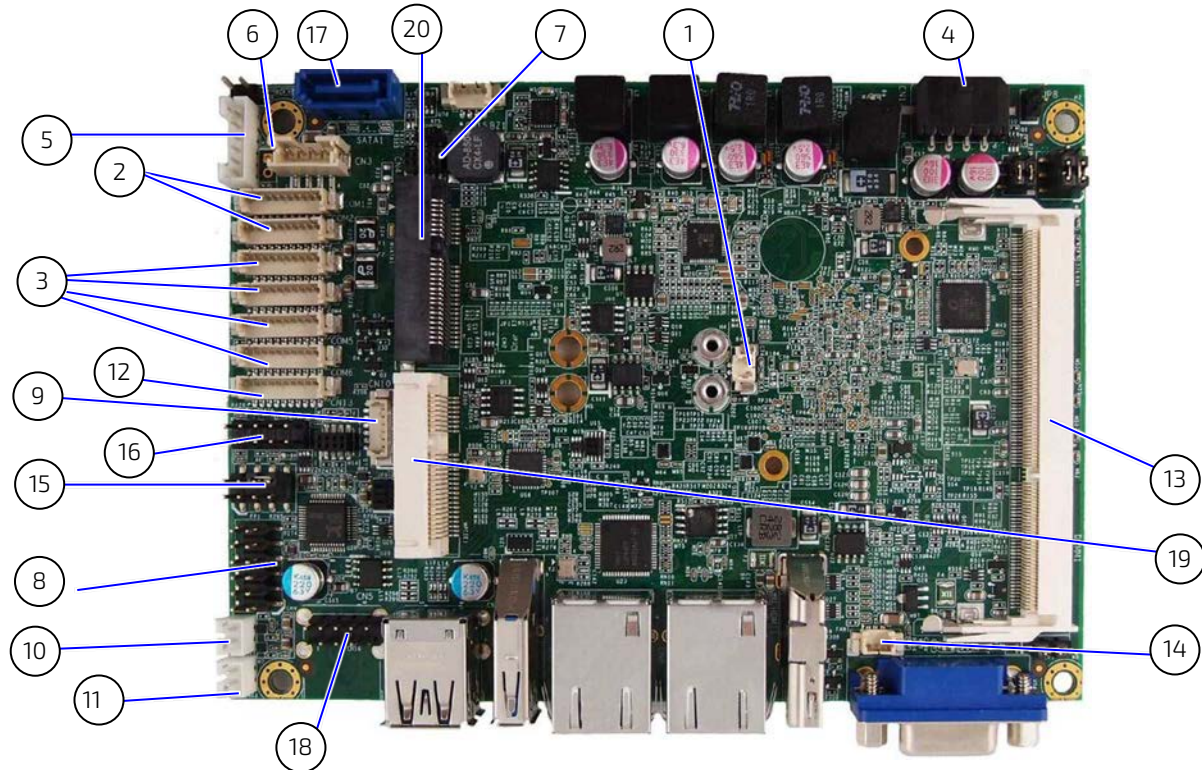

Table 11: Internal Connectors Top side

Item	Function
1	Battery power input
2	RS-232 Port 1~2connectors (on the front panel)
3	RS-232 Port 3~6 connector ( option)
4	Power Input connector
5	PS/2 Keyboard / Mouse connector
6	HDD Power Output connector
7	P80_Header
8	Audio Input / Output Pin Header
9	SIM Interface for MPCIE1
10	Right Channel 3W Audio AMP Output connector
11	Left Channel 3W Audio AMP Outputconnector
12	Digital Input / Output Pin Header
13	DDR3 Memory SODIMM Socket (standard 4 GB/optional 8 GB)
14	CPU FAN connector
15	Front Panel 1 Pin Header
16	Front Panel 2 Pin Header
17	Serial ATA Port 0 Connector
18	USB Port connector
18	USB 2.0 Port USBDN_1.2 Pin Header
19	Mini-PCIE Express v1.2 Socket (full size)
20	Mini-SATA (full size)

## 12.4. Internal Connector and Socket Pin Assignments

### 12.4.1. 12 V DC Out Power Connector

An internal 24 V DC to 12 V DC converter board converts the nominal Input voltage of 24 V DC from the front panel Input power connector, to 12 V DC. The internal component are supplied from the internal 4-pin 12 V DC out power connector.

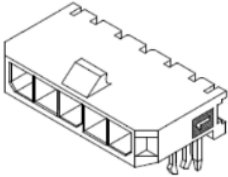
4-pin Power	Pin	Signal Name
	1	+12 V
	2	GND
	3	GND
	4	+12V

### 12.4.2. Battery Power Input Connector

	Pin	Signal Name
	1	+VBAT
	2	GND

### 12.4.3. HDD Power Output Connector

	Pin	Signal Name
	1	+12 V
	2	GND
	3	GND
	4	+5V

### 12.4.4. Front Panel 1-Pin Header

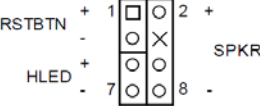
	Pin	Signal Name	Pin	Signal Name
	1	Reset Button +	2	Speaker+
	3	Reset Button -	4	NC
	5	HDD LED+	6	Internal Speaker- <sup>[1]</sup>
	7	HDD LED-	8	Speaker- <sup>[1]</sup>

<sup>[1]</sup> Internal buzzer enabled by shorting pin 6 and pin 8.

### 12.4.5. Front Panel 2-Pin Header

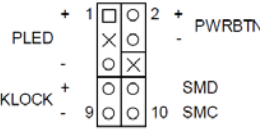
	Pin	Signal Name	Pin	Signal Name
	1	Power LED +	2	Power Button +
	3	NC	4	Power Button -
	5	Power LED -	6	SMBALERT#
	7	BatLow#	8	SMBus DATA
	9	GND	10	SMBus Clock

### 12.4.6. Serial ATA Port 0 Connector

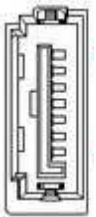
	Pin	Signal Name
	1	GND
	2	TX+
	3	TX-
	4	GND
	5	RX+
	6	RX-
	7	GND

### 12.4.7. mPCIe Express V 1.2 Socket – Full Size

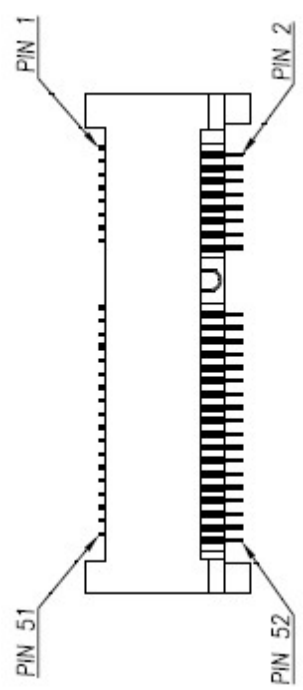
	Signal Name	Pin	Pin	Signal Name
	WAKE#	1	2	+3.3 VSB
	Reserved	3	4	Ground
	Reserved	5	6	+1.5 V
	CLKREQ#	7	8	UIM_PWR <sup>[1]</sup>
	Ground	9	10	UIM_DATA <sup>[1]</sup>
	REFCLK-	11	12	UIM_CLK <sup>[1]</sup>
	REFCLK+	13	14	UIM_RESE <sup>[1]</sup>
	Ground	15	16	UIM_VPP <sup>[1]</sup>
	Reserved	17	18	Ground
	Reserved	19	20	W_Disable#
	Ground	21	22	PERST#
	PERn0	23	24	+3.3 VSB
	PERp0	25	26	Ground
	Ground	27	28	+1.5 V
	Ground	29	30	SMB_CLK
	PETn0	31	32	SMB_DATA
	PETp0	33	34	Ground
	Ground	35	36	USB_D-
	Ground	37	38	USB_D+
	+3.3 VSB	39	40	Ground
	+3.3 VSB	41	42	LED_WWAN#
	Ground	43	44	LED_WLAN#
	Reserved	45	46	LED_WPAN#
	Reserved	47	48	+1.5 V
	Reserved	49	50	Ground
	Reserved	51	52	+3.3 VSB

<sup>[1]</sup> These pins are connected to the SIM Interface wafer directly.



### 12.4.8. mSATA Socket Serial ATA port 1- Full Size

	Signal Name	Pin	Pin	Signal Name
	NC	1	2	+3.3V
	NC	3	4	Ground
	NC	5	6	NC
	N/A	7	8	NC
	Ground	9	10	NC
	NC	11	12	NC
	NC	13	14	NC
	Ground	15	16	NC
	NC	17	18	Ground
	NC	19	20	NC
	Ground	21	22	NC
	SATA_RX+	23	24	+3.3V
	SATA_RX-	25	26	Ground
	Ground	27	28	NC
	Ground	29	30	NC
	SATA_TX-	31	32	NC
	SATA_TX+	33	34	Ground
	Ground	35	36	NC
	Ground	37	38	NC
	+3.3V	39	40	Ground
	+3.3V	41	42	NC
	Ground	43	44	NC
	NC	45	46	NC
	NC	47	48	NC
	NC	49	50	Ground
	NC	51	52	+3.3V

## 12.5. Jumpers

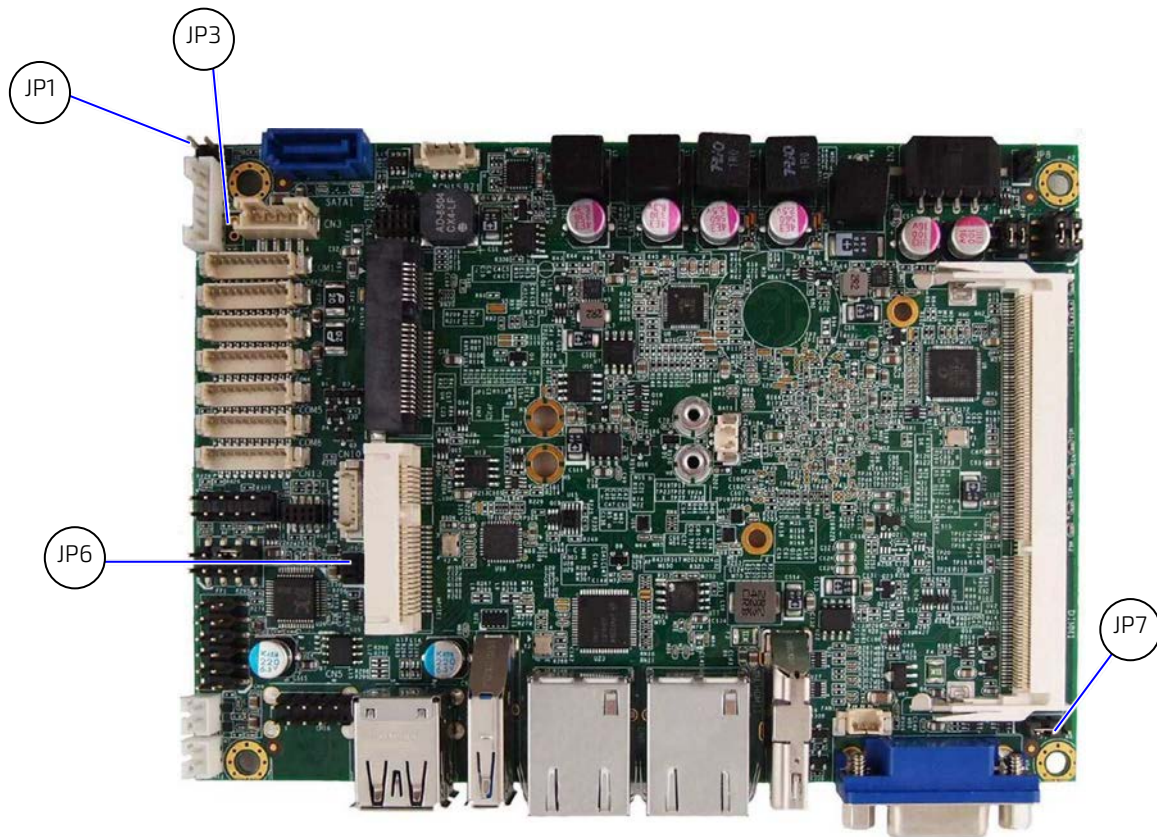

Table 12: Jumpers

Label	Function
JP1	RTC Reset Selection
JP3	RTC Battery Test
JP6	USB Power Selection
JP7	AT / ATX Power Mode Selection

## 12.6. Jumper Pin Assignments

### 12.6.1. RTC Reset Selection (JP1) Pitch 2.54 mm

	Jumper	Status
	1-2 open	Normal Operation
	1-2 short	Clear ME Registers

### 12.6.2. RTC Battery Test (JP3) Pitch 2.54 mm

	Jumper	Status
	1-2 open	Normal
	1-2 short	Reserved

**12.6.3. USB Power Selection (JP6) Pitch 2.00 mm**

	Jumper	Status
	1-2 short	USB power will be cut off in S4 & S5 state.
	1-2 open	USB power is always supply.

**12.6.4. AT/ATX Power Mode Selection (JP7) Pitch 2.54 mm**

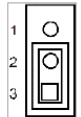
	Jumper	Status
	1-2 short	AT Mode
	2-3 short	AT Mode (default)

## 13/ BIOS

The KBox-A-150-BYT uses the AMI uEFI BIOS supported by the mainboard and based on the Unified Extensible Firmware Interface (uEFI) specification and the Intel® Platform Innovation Framework for EFI. The AMI uEFI BIOS preferences are preset and do not require further adjustment for operation. The AMI BIOS setup menus and available selection may vary. The uEFI BIOS features enhanced functions specifically tailored to the KBox A-150-BYT's hardware features:

- ▶ Configurable COMs (RS232, RS422, RS485)
- ▶ Configurable power settings
- ▶ Additional display configurations

For specific information on the BIOS for your product, contact [Kontron Support](#).



The BIOS information covered in this document might not be for the latest version. The latest version might have certain differences to the BIOS options and features described in this chapter. For the BIOS information specific for your product, contact [Kontron Support](#).

### 13.1. Starting the uEFI BIOS

The uEFI BIOS comes with a Setup program that provides quick and easy access to the individual function settings for control or modification of the uEFI BIOS configuration. The Setup program allows for access to various menus that provide functions or access to sub-menus with further specific functions of their own.

To start the uEFI BIOS Setup program, follow the steps below:

1. Power-on the board.
2. Wait until the first characters appear on the screen (POST messages or splash screen).
3. Press the <DEL> key.
4. If the uEFI BIOS is password-protected, a request for password will appear. Enter either the User Password or the Supervisor Password, press <RETURN>, and proceed with step 5.
5. The BIOS setup utility appears in the Main menu

Using the hot key navigation system users can navigate through the BIOS. The hot key legend bar is located at the bottom of the Setup screens. The following table provides a list of navigation hot keys available in the legend bar.

**Table 13: Navigation Hot Keys Available in the Legend Bar**

Sub-screen	Description
<F1>	<F1> key invokes the General Help window
<->	<Minus> key selects the next lower value within a field
<+>	<Plus> key selects the next higher value within a field
<F2>	<F2> key loads previous values
<F3>	<F3> key loads optimized defaults
<F4>	<F4> key Saves and Exits
<←> or <→>	<Left/Right> arrows selects major Setup menus on menu bar, for example, Main or Advanced
<↑> or <↓>	<Up/Down> arrows select fields in the current menu, for example, Setup function or sub-screen
<ESC>	<ESC> key exits a major Setup menu and enters the Exit Setup menu Pressing the <ESC> key in a sub-menu displays the next higher menu level
<RETURN>	<RETURN> key executes a command or selects a submenu

## 13.2. Setup Menus

The Setup utility features menus listed in the selection bar at the top of the screen are:

- ▶ Main
- ▶ Advanced
- ▶ Boot
- ▶ Security
- ▶ Save & Exit

The currently active menu and the currently active BIOS Setup item are highlighted in white. Use the left and right arrow keys to select the Setup menus.

Each Setup menu provides two main frames. The left frame displays all available functions. Configurable functions are displayed in blue. Functions displayed in grey provide information about the status or the operational configuration. The right frame displays an explanation of the respective function in a help window.

### 13.2.1. Main Setup Menu

Figure 27: Main Setup Menu Example

BIOS SETUP UTILITY				
Main	Advanced	Boot	Security	Save & Exit
Product Information				→ ← Select Screen ↑↓ Select Item Enter: Select +- Change Opt. F1: General Help F2: Previous Values F3: Optimized Defaults F4 Save & Exit ESC Exit
Product Name		KEEX-1760		
BIOS Version		R0.0A (x64)		
BIOS Build Date		05/26/2014		
ME FW Version		01.01.00.1089		
CPU Information				
Intel® Celeron® CPU J1900@1.99GHz				
Microcode Revision		809		
Processor Cores		4		
Memory Information				
Total Size		4096 MB (DDR3L)		
Frequency		1333 MHz		
System date		[Mon 05/26/2014]		
System time		[13:23:12]		
Access Level		Administrator		

The Main Menu provides an overview of the BIOS information and enables users to set the system date and time.

### 13.2.2. Advanced Setup Menu

Figure 28: Advanced Setup Menu Example

BIOS SETUP UTILITY	
Main	Advanced
Onboard LAN1 Controller	[Enabled]
Onboard LAN1 Boot	[Disabled]
Onboard LAN2 Controller	[Enabled]
Onboard LAN2 Boot	[Disabled]
Audio Controller	[Enabled]
> Display Configuration	
> Super IO Configuration	
> CPU Chipset Configuration	
> SATA Configuration	
> USB Configuration	
> DIO Configuration	
> H/W Monitor	

→ ← Select Screen  
 ↑↓ Select Item  
 Enter: Select  
 +- Change Opt.  
 F1: General Help  
 F2: Previous Values  
 F3: Optimized Defaults  
 F4 Save & Exit  
 ESC Exit

The following table gives information about important setup options within the Advanced Menu. Default setting are displayed in **bold**.

Table 14: Advanced Menu

Sub-screen	Additional Sub-screens with Description	
Onboard LAN 1 Controller	[Enabled, Disabled]	
Onboard LAN 1 Boot	[Enabled, <b>Disabled</b> ]	
Onboard LAN 2 Controller	[Enabled, Disabled]	
Onboard LAN 2 Boot	[Enabled, <b>Disabled</b> ]	
Audio Controller	[Enabled, Disabled]	
Display Configuration	Primary Display	[Auto, <b>IGD</b> ]
	UMA Frame Buffer Size	[128MB, <b>256MB</b> , 512MB]
	DVMT Pre-Allocated	[ <b>64M</b> , 96M, 128M, 160M, 192M, 224M, 256M, 288M, 320M, 352M, 384M, 416M, 448M, 480M, 512M]
	DVMT Total Gfx Mem	[128M, <b>256M</b> , MAX]
	Primary IGFX Boot Display	[ <b>VBIOS Default</b> , CRT, HDMI, LVDS]
	Active LVDS	[Enabled, <b>Disabled</b> ]
Super IO Configuration	Serial Port 1 Configuration	Serial Port [Enabled, Disabled]
		Device Settings [ <b>IO=3F8h; IRQ=4</b> ]
		Change Settings Auto

Sub-screen	Additional Sub-screens with Description		
Super IO Configuration	Serial Port 1 Configuration (continued)		<b>IO=3F8h; IRQ=4;</b> IO=3F8h; IRQ=3, 4, 5, 6, 7, 9, 10, 11, 12; IO=2F8h; IRQ=3, 4, 5, 6, 7, 9, 10, 11, 12; IO=3E8h; IRQ=3, 4, 5, 6, 7, 9, 10, 11, 12; IO=2E8h; IRQ=3, 4, 5, 6, 7, 9, 10, 11, 12;
		Serial Port 1 Type	[ <b>RS232</b> , RS422, RS485]
	Serial Port 2 Configuration	Serial Port	[ <b>Enabled</b> , Disabled]
		Devive Settings	[ <b>IO=2F8h; IRQ=3</b> ]
		Change Settings	Auto <b>IO=2F8h; IRQ=3;</b> IO=3F8h; IRQ=3, 4, 5, 6, 7, 9, 10, 11, 12; IO=2F8h; IRQ=3, 4, 5, 6, 7, 9, 10, 11, 12; IO=3E8h; IRQ=3, 4, 5, 6, 7, 9, 10, 11, 12; IO=2E8h; IRQ=3, 4, 5, 6, 7, 9, 10, 11, 12
		Serial Port 2 Type	[ <b>RS232</b> , RS422, RS485]
	Serial Port 3 Configuration	Serial Port	[Enabled, <b>Disabled</b> ]
	Serial Port 4 Configuration	Serial Port	These serial ports are not connected on the standard product. (option)
	Serial Port 5 Configuration	Serial Port	
	Serial Port 6 Configuration	Serial Port	
CPU Advanced Configuration	EIST	[ <b>Enabled</b> , Disabled]	
	Turbo Mode	[ <b>Enabled</b> , Disabled]	
	Limit CPUID Maximum	[Enabled, <b>Disabled</b> ]	
	Execute Disable Bit	[ <b>Enabled</b> , Disabled]	
	Intel® Virtualization Tech	[Enabled, <b>Disabled</b> ]	
SATA Configuration	Serial-ATA (SATA)	[ <b>Enabled</b> , Disabled]	
	SATA Mode	[IDE Mode, <b>AHCI Mode</b> ]	
	Serial ATA Port 1		
	Port 1	[ <b>Enabled</b> , Disabled]	
	mSATA Port 1		
	Port 1	[ <b>Enabled</b> , Disabled]	
USB Configuration	Legacy USB Support	[ <b>Enabled</b> , Disabled, Auto]	
	XHCI Legacy Support	[ <b>Enabled</b> , Disabled]	
	XHCI Hand-off	[ <b>Enabled</b> , Disabled]	
	EHCI Hand-off	[Enabled, <b>Disabled</b> ]	
	USB Mass Storage Driver Support	[ <b>Enabled</b> , Disabled]	
	XHCI Mode	[Smart Audio, <b>Enabled</b> ]	
DIO Configuration	User Configured	[Enabled, <b>Disabled</b> ]	

Sub-screen	Additional Sub-screens with Description		
DIO Configuration	DIO-0	[Output Low, Output High, Input]	
	DIO-1	[Output Low, Output High, Input]	
	DIO-2	[Output Low, Output High, Input]	
	DIO-3	[Output Low, Output High, Input]	
	DIO-4	[Output Low, Output High, Input]	
	DIO-5	[Output Low, Output High, Input]	
	DIO-6	[Output Low, Output High, Input]	
	DIO-7	[Output Low, Output High, Input]	
	DIO-0 Value	1	
	DIO-1 Value	1	
	DIO-2 Value	1	
	DIO-3 Value	1	
	DIO-4 Value	1	
	DIO-5 Value	1	
	DIO-6 Value	1	
	DIO-7 Value	1	
Network Stack	[Enabled, <b>Disabled</b> ]		
	Ipv4 PXE Support	[Enabled, Disabled]	
	Ipv6 PXE Support	[Enabled, Disabled]	
	PXE Boot wait time	0	
	<b>Additional Information</b> Only available if the Boot Option filter = UEFI only or UEFI and legacy		
H/W Monitor	CPU Warning Temperature	[Disabled, 80, 85, 90, 95]	
	Smart Fan Configuration	CPU FAN Setting	[Manual, Smart]
		Manual Duty	[0..255]
	Read only text CPU temperature, System temperature, CPU fan speed, +VCore, +Vin, +5 V, +VMEN		
Power Configuration	ACPI Sleep State	[Suspend Disabled, <b>S3 (Suspend to RAM)</b> ]	
	Power Saving Mode	[Enabled, <b>Disabled</b> ]	
	Resume Event Control		
	Resume From S3 By PS/2 Keyboard	[Enabled, <b>Disabled</b> ]	
	Resume From S3 By PS/2 Mouse	[Enabled, <b>Disabled</b> ]	
	Resume By PCIE Device	[Enabled, <b>Disabled</b> ]	
	Resume By RingRTC Alarm	[Enabled, <b>Disabled</b> ]	
	Resume By Ringdevice	[Enabled, <b>Disabled</b> ]	



Sub-screen	Additional Sub-screens with Description		
Power Configuration	Watchdog Timer Configuration	WDT Function	[Enabled, <b>Disabled</b> ]
		WDT Count Mode	[ <b>Second</b> , minute]
		WDT Timer	[0.. <b>30</b> ..255]

### 13.2.3. Boot Setup Menu

Figure 29: Boot Setup Menu Example

BIOS SETUP UTILITY				
Main	Advanced	<b>Boot</b>	Security	Save & Exit
Boot Configuration Full Screen LOGO Display [Disabled] Setup Prompt Timeout 1 Bootup NumLock State [On] Keyboard Detect Warning [Enabled] CSM Support [Enabled] Boot Option Filter [Legacy Only]			→ ← Select Screen ↑↓ Select Item Enter: Select +- Change Opt. F1: General Help F2: Previous Values F3: Optimized Defaults F4 Save & Exit ESC Exit	
Boot Option Priorities				

The following table gives more information for important setup options within the Boot Menu. Default settings are displayed in **bold**.

Table 15: Boot Setup Menu Sub-screens and Functions

Function	Description
Full Screen LOGO Display	Full Screen LOGO Display Options: [ <b>Disabled</b> , Enabled]
Setup Prompt Timeout	Displays number of seconds that the firmware waits for setup activation key The value 65535(0xFFFF) means an indefinite wait. [ <b>1</b> ]
Bootup NumLock State	Selects keyboard NumLock state [ <b>ON</b> , OFF]
CSM Support	[ <b>Enabled</b> , Disabled]
Boot Option Filter	[ <b>UEFI and legacy</b> , Legacy only, UEFI only, Disabled]
Boot Option #1	Dependent on the attached storage device
Hard Drive BBS Priorities	Dependent on the attached storage device

### 13.2.4. Security Setup Menu

Figure 30: Security Setup Menu Example

BIOS SETUP UTILITY				
Main	Advanced	Boot	<b>Security</b>	Save & Exit
Password Description  If <b>ONLY</b> the Administrator's password is set, then this only limits access to Setup and is only asked for when entering Setup If <b>ONLY</b> the User's password is set, then this is a power on password and must be entered to boot or enter Setup. In Setup the User will have Administrator rights The password length must be in the following range: Minimum Length <b>3</b> Maximum length <b>20</b>  Administrator Password User Password  HDD Security Configuration: HDD 0: WDC WD1600BE			→ ← Select Screen ↑↓ Select Item Enter: Select +- Change Opt. F1: General Help F2: Previous Values F3: Optimized Defaults F4 Save & Exit ESC Exit	

The following table gives more information for important setup options within the Security Menu. Default settings are displayed in **bold**.

Table 16: Security Setup Menu Sub-screens and Functions

Function	Description		
Administrator Password	Sets administrator password		
User Password	Sets user password		
HDD Security Configuration	Read only information Allows access to set, modify and clear Hard Disk user and master passwords. User Passwords need to be installed for Enabling Security. Master Password can be modified only when successfully unlocked with the Master Password in Post.		
	Secure Boot Menu	Read only field System Mode = Setup and Secure Boot = Not Active	
		Secure Boot	[Enabled, <b>Disabled</b> ]
		Secure Boot Mode	[Standard, Custom]

### 13.2.5. Save and Exit Setup Menu

Figure 31: Save and Exit Set up Menu Example

BIOS SETUP UTILITY				
Main	Advanced	Boot	Security	Save & Exit
Save Changes and Reset Discard Changes and Reset  Save Options Save Changes Discard Changes  Restore Defaults			→ ← Select Screen ↑↓ Select Item Enter: Select +- Change Opt. F1: General Help F2: Previous Values F3: Optimized Defaults F4 Save & Exit ESC Exit	

The following table gives more information for important setup options within the Save and Exit Menu. Default settings are displayed in **bold**.

Table 17: Save and Exit Setup Menu Sub-screens and Functions

Function	Description
Save Changes and Reset	Exits system after saving changes Once you are finished making your selections, choose this option to ensure the values you selected are saved to the CMOS RAM. The CMOS RAM is sustained by an onboard backup battery and stays on even when the PC is turned off. When you select this option, a confirmation window appears. Select [ <b>Yes</b> ] to save changes and exit.
Discard Changes and Exit	Exits system setup without saving changes Select this option only if you do not want to save the changes that you made to the Setup program. If you made changes to fields other than system date, system time, and password, the BIOS will asks for a confirmation before exiting.
Save Option	Saves changes made so far for any setup options
Save Changes	Saves changes made so far for any setup options
Discard Changes	Discards changes made so far to any of the setup values This option allows you to discard the selections you made and restore the previously saved values. After selecting this option, a confirmation appears. Select [ <b>Yes</b> ] to discard any changes and load the previously saved values.
Restore Defaults	Restores/loads standard default values for all setup options <u>Load Optimal Default values for all the setup values</u> This option allows you to load optimal default values for each of the parameters on the Setup menus, that provides the best performance settings The F9 key can be used for this operation. <u>Load Failsafe Default values for all the setup values</u> This option allows you to load failsafe default values for each of the parameters on the Setup menus, that provides the most stable performance settings. The F8 key can be used for this operation.

## 14/ Technical Support

For technical support contact Kontron's Support department:

- ▶ E-mail: support@kontron.com
- ▶ Phone: +49-821-4086-888

Make sure you have the following information available when you call:

- ▶ Product ID Number (PN)
- ▶ Serial Number (SN)



---

The serial number can be found on the product's type label.

---

### 14.1. Returning Defective Merchandise

All equipment returned to Kontron must have a Return of Material Authorization (RMA) number assigned exclusively by Kontron. Kontron cannot be held responsible for any loss or damage caused to the equipment received without an RMA number. The buyer accepts responsibility for all freight charges for the return of goods to Kontron's designated facility. Kontron will pay the return freight charges back to the buyer's location in the event that the equipment is repaired or replaced within the stipulated warranty period. Follow these steps before returning any product to Kontron.

1. Visit Kontron's [RMA Information website](#).
2. Download the RMA Request sheet for **Kontron Europe GmbH - Ismaning** and fill out the form. Take care to include a short detailed description of the observed problem or failure and to include the product identification (Name of product, product number and serial number). If a delivery includes more than one product, fill out the above information in the RMA Request form for each product
3. Send the completed RMA-Request form to the fax or email address given on the RMA Request sheet and Kontron will provide an RMA-Number.
4. The goods for repair must be packed properly for shipping, considering shock and ESD protection.



---

Goods returned to Kontron Europe GmbH in non-proper packaging will be considered as customer caused faults and cannot be accepted as warranty repairs.

---

5. Include the RMA-Number with the shipping paperwork and send the product to the delivery address provided in the RMA form or received from Kontron RMA Support.

## 15/ Storage, Transportation and Maintenance

### 15.1. Storage

If the product is not in use for an extended period time, disconnect the power plug from the AC outlet .If it is necessary to store the product then re-pack the product as originally delivered to avoid damage. The storage facility must meet the products environmental requirements as stated within this user guide. Kontron recommends keeping the original packaging material for future storage or warranty shipments.

### 15.2. Transportation

To ship the product use the original packaging, designed to withstand impact and adequately protect the product. When packing or unpacking products always take shock and ESD protection into consideration and use an EOS/ESD safe working area.

### 15.3. Maintenance

Maintenance or repair on the open product may only be carried out by qualified personnel authorized by Kontron.

#### 15.3.1. Cleaning

- ▶ For light soiling, clean the product with a dry cloth.
- ▶ Carefully remove dust from the surface of the chassis using a clean, soft brush.
- ▶ Stubborn dirt should be removed using a mild detergent and a soft cloth

#### 15.3.2. Replacing the Lithium Battery

If the on-board Lithium battery (CR 2032, 3V) needs to be replaced, follow the steps below:

1. Remove the lithium battery from the holder by pulling it outwards.
2. Place a new lithium battery in the battery holder.
3. Pay attention to the polarity of the battery.
4. The lithium battery must only be replaced with the same type of battery or with a type of battery recommended by Kontron.

#### **CAUTION**

Caution: Risk of Explosion if Battery is replaced by an Incorrect Type. Dispose of Used Batteries According to the Instructions.

ATTENTION: Risque d'explosion si la batterie est remplacée par un type incorrect. Mettre au rebus les batteries usagées selon les instructions.



The KBox A-150-BYT is not designed to operate without a battery. If the battery is empty or disconnected, the BIOS settings will be set to the factory defaults.



Do not dispose of lithium batteries in general trash collection. Dispose of the battery according to the local regulations dealing with the disposal of these special materials, (e.g. to collecting points for battery disposal).

## 16/ Warranty

Kontron defines product warranty in accordance with regional warranty definitions. Claims are at Kontron's discretion and limited to the defect being of a material nature. To find out more about the warranty conditions and the defined warranty period for your region, following the steps below:

1. Visit Kontron's [Term and Conditions webpage](#).
2. Click on your region's General Terms and Conditions of Sale.



---

The KBox A-150-BYT is factory configured to meet customer requirements. Kontron does not recommend opening the product as this may cause damage to internal components.

---

### 16.1. Limitation/Exemption from Warranty Obligation

In general, Kontron shall not be required to honor the warranty, even during the warranty period, and shall be exempted from the statutory accident liability obligations in the event of damage caused to the product due to failure to observe the following:

- ▶ General safety instructions within this user guide
- ▶ Warning labels on the product and warning symbols within this user guide
- ▶ Information and hints within this user guide

Additionally, alterations or modifications to the product that are not explicitly approved by Kontron, described in this user guide, or received from Kontron Support as a special handling instruction will void your warranty.

Within the warranty period, the product should only be opened by Kontron. Removing the protection label and opening the product within the warranty period exempts the product from the statutory warranty obligation.

Due to their limited service life, parts which by their nature are subject to a particularly high degree of wear (wearing parts) are excluded from the warranty beyond that provided by law.

## Appendix: List of Acronyms

Table 18: List of Acronyms

AC	Alternating Current
ACPI	Advanced Configuration Control Interface
CPU	Central Processing Unit
DC	Direct Current
DIO	Digital Input/Output
DP	Display Port
ECC	Error Checking and Correction
EHCI	Enhanced Host Controller Interface
ESD	Electrostatic Discharge
GbE	Gigabit Ethernet
GPU	Graphics Processing Unit
HD/HDD	Hard Disk /Drive
HDMI	High Definition Multimedia Interface
HPM	PICMG Hardware Platform Management specification family
H/W	Hardware
IOL	IPMI-Over-LAN
IOT	Internet of Things
KVM	Keyboard Video Mouse
LAN	Local Area Network
LPS	Limited Power Source
LVD	Low Voltage Device
M.2	Next smaller generation of mSATA
MEI	Management Engine Interface

mPCIe	Mini PCI-Express
mSATA	Mini SATA
OS	Operating System
PCIe	PCI-Express
RAM	Read Access Memory
RoHS	Restriction of the use of certain hazardous substances
RTC	Real Time Clock
SATA	Serial-ATA
SEL	System Event Log
SELV	Safety Extra Low Voltage
SIO	Super Input/output
SMBus	System Management Bus
SMWI	System Monitor Web Interface
SOL	Serial Over LAN
SSD	Solid State Drive
TPM	Trusted Platform Module
UEFI	Unified Extensible Firmware Interface
USB	Universal Serial Bus
VGA	Video Graphics Array
VLP	Very Low Profile
WEEE	Waste Electrical and Electronic Equipment
WLAN	Wireless LAN
XHCI	eXtensible Host Controller Interface





## About Kontron

Kontron is a global leader in IoT/Embedded Computing Technology (ECT). Kontron offers individual solutions in the areas of Internet of Things (IoT) and Industry 4.0 through a combined portfolio of hardware, software and services. With its standard and customized products based on highly reliable state-of-the-art technologies, Kontron provides secure and innovative applications for a wide variety of industries. As a result, customers benefit from accelerated time-to-market, lower total cost of ownership, extended product lifecycles and the best fully integrated applications.

For more information, please visit: [www.kontron.com](http://www.kontron.com)



## Global Headquarters

### Kontron Europe GmbH

Gutenbergstraße. 2  
85737 Ismaning  
Germany  
Tel.: +49 821 4086-0  
Fax: +49 821 4086-111  
[info@kontron.com](mailto:info@kontron.com)